

Derwent
Top 100
Global
Innovator
2020

Meta-MEC Manual Motor Starters



LS ELECTRIC

LS Meta-MEC Manual Motor Starters provide completed ranges up to 100A



32AF

63AF

32AF

0.1~0.16... 28~40A (17 step)

MMS-32S



Standard

**MMS-32H
MMS-32HI**



High break
Magnetic release

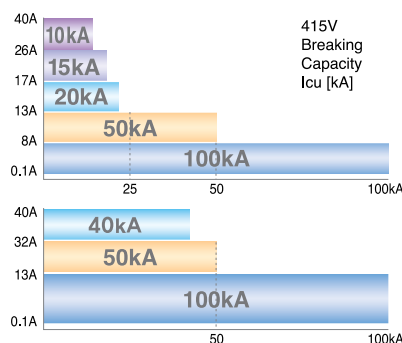

6~10... 47~65A (10 step)

MMS-63S



Standard

**MMS-63H
MMS-63HI**



High break
Magnetic release

up to 100A



MMS

100AF

63AF

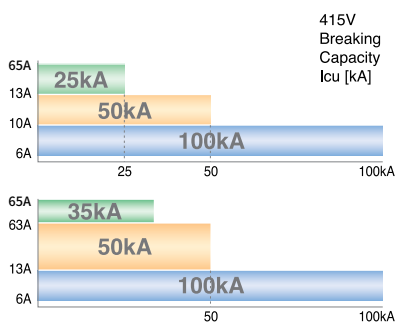

11~17... 80~100A (10 step)

MMS-100S

Standard

MMS-100H
MMS-100HI

High break
Magnetic release



100AF

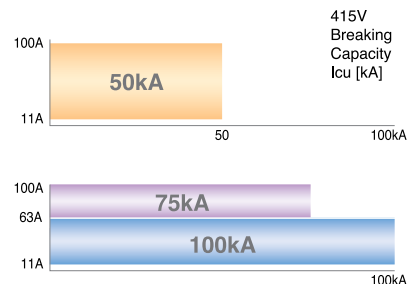

LS Meta-MEC Manual Motor Starters deliver more efficiency through various functions and compact design

MMS 32H... 32A [Scale 1:1]

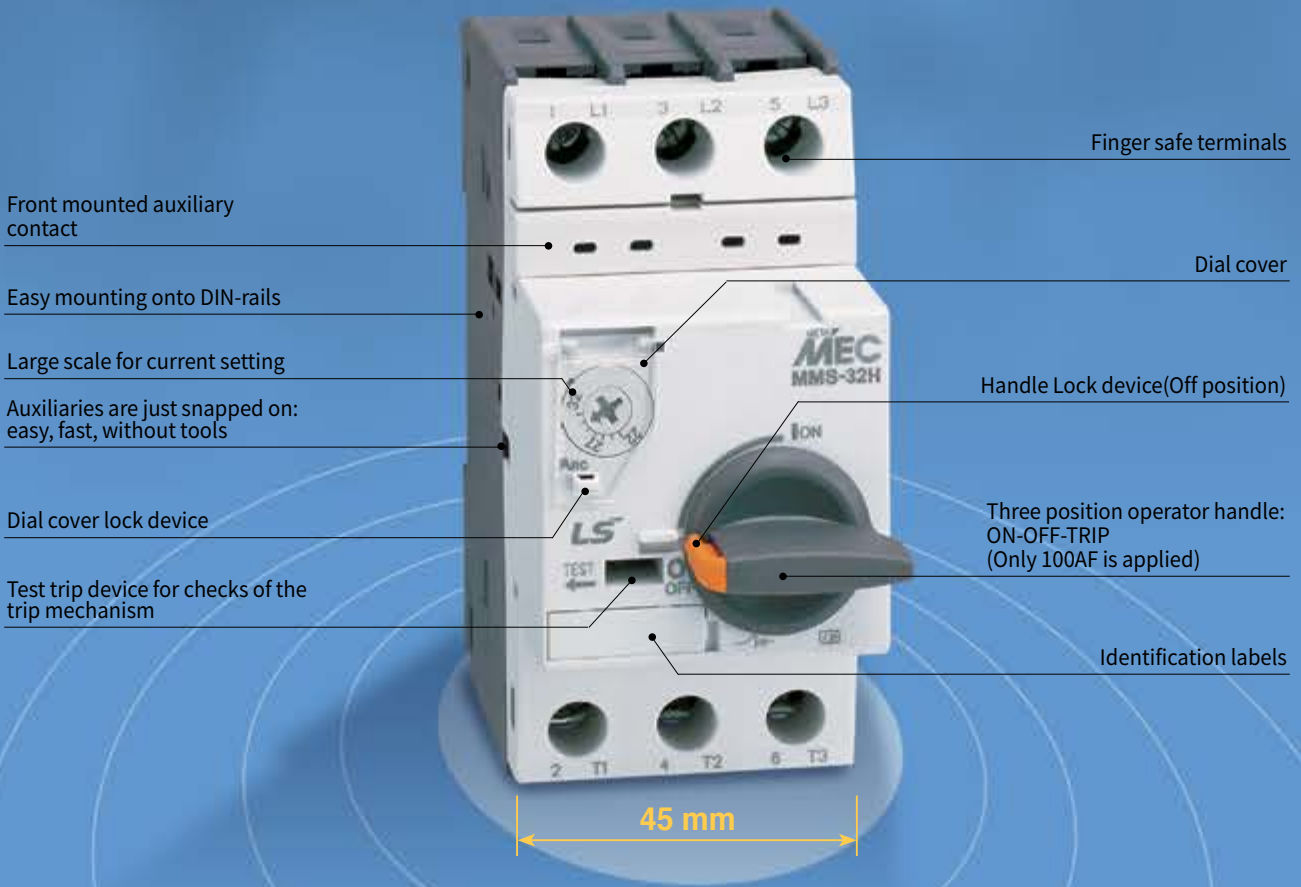

Handle Lock



Dial cover



Terminals

MMS-32



Screw

MMS-63



Lug

MMS-100



Lug

Common use from 32 to 100AF

A wide variety of accessories enables a flexible response to changes in specifications

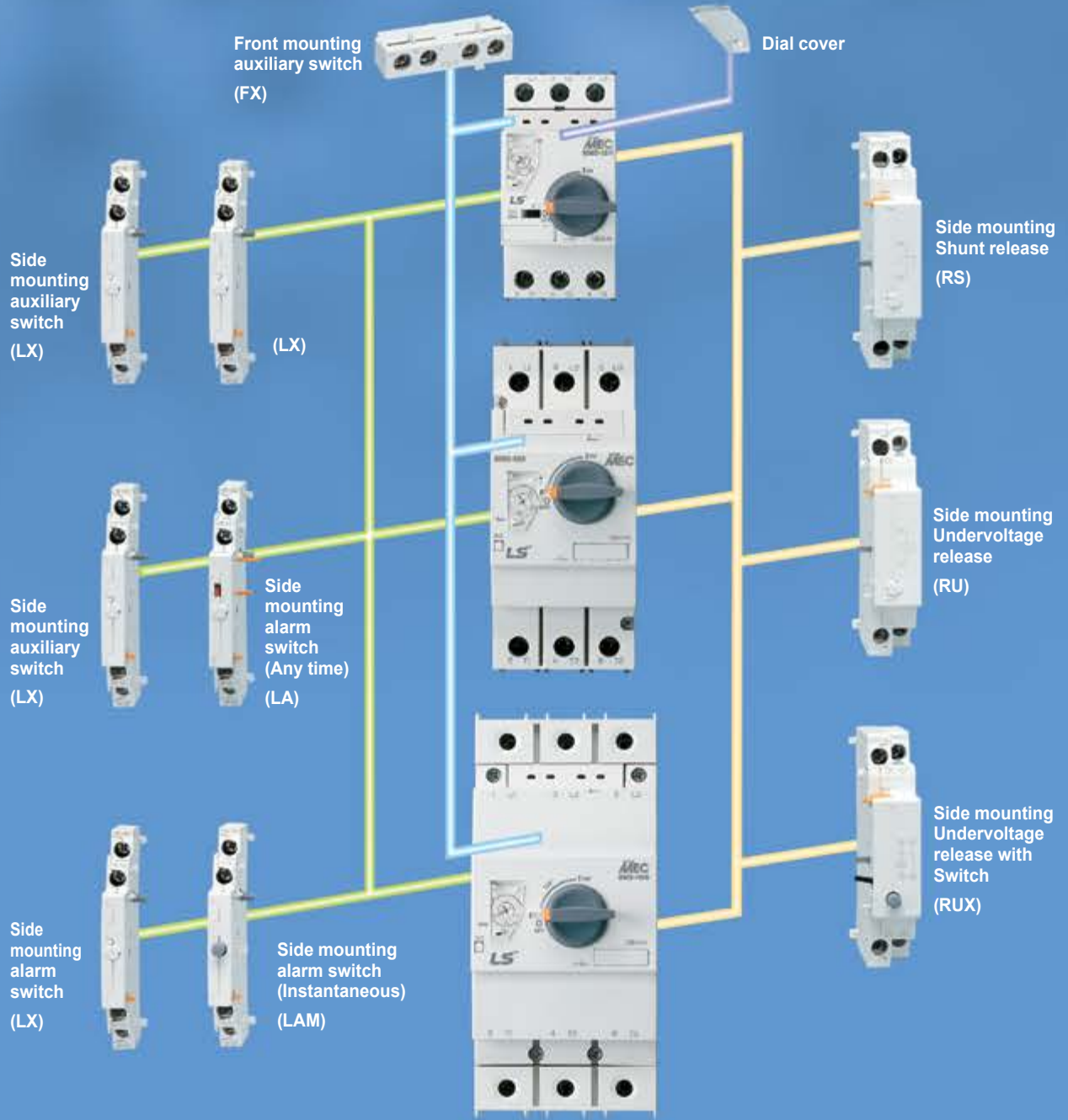

Function

- Protection of group installation
- Protection of circuits
- Motor protection
- Starter protection
- Wide range of ambient temperature compensation
- Phase failure protection



Feature

- 45mm width(32AF), 55mm width(63AF), 70mm width(100AF)
- Three position operator : ON-OFF-TRIP (Only 100AF is applied)
- Complete range of common accessories
- Handle lock in the OFF position
- Class 10 overload trip characteristics
- Trip test
- Finger safe terminal
- Din rail & Screw mounting
- Ready for IE3

Standard

- Comply with the specifications in accordance with IEC 60947-2 & IEC 60947-4-1
- UL508 (Manual motor controller)
- UL508 (Combination motor controller type E starter)
- CSA C22.2 NO.14
- GB14048

Certification

- KEMA CB type certificate
- EC-Declaration of conformity
- UL listed
- CSA certified
- CCC



Contents



Product Selection Guide

Quick selection table ... IEC rating	8
Standard type	10
High breaking type	11
Instantaneous type	12
Accessories	13

Technical Information

General data	18
IEC performance data (Motor protection)	27
Manual motor controller (UL 508, CSA C22.2 as Manual motor controllers)	31
Manual Motor Controller (UL508)	33
Type '2' coordination according to IEC 60947-4-1	35
IE3-rated motor	36
Thermal limit on short circuit for MMS	38
Dimensions	42



Manual Motor Starters

Product Selection Guide

Quick selection table ... IEC rating



Frame			32AF																				
Type	Current adjustable type		MMS-32S							MMS-32H													
	Instantaneous type		-							MMS-32HI													
Breaking capacity			Standard							High breaking													
Handle Type			Toggle							Rotary													
Number of poles			3							3													
Rated operational voltage (Ue)			Up to 690V							Up to 690V													
Rated frequency			50/60 Hz							50/60 Hz													
Rated insulation voltage (Ui)			690V							690V													
Rated impulse voltage (Uimp)			6kV							6kV													
Utilization category			Cat. A							Cat. A													
			IEC 60 947-2 (Breaker)							IEC 60 947-4 (Motor starter)													
Mechanical endurance (Operating)			100,000							100,000													
Electrical endurance (Cycles)			100,000							100,000													
Max operating frequency per hour (Ope./h)			25							25													
Temperature compensation (Operation)			-20 ~ +60°C							-20 ~ +60°C													
Instantaneous short circuit release			13 × Ie max.							13 × Ie max.													
Overload protection			o							o													
Phase failure function			o							o													
Trip indicating function			x							x													
Test function			o							o													
Weight (g)			320							360													
Rated breaking capacity (kA)	Rated operational current (Ie)	Thermal release Adjustment range (Ie)	220V 240V 230V		415V 400V		460V 440V		525V 500V		690V 600V		220V 240V 230V		415V 400V		460V 440V		525V 500V		690V 600V		
			Icu	Ics	Icu	Ics	Icu	Ics	Icu	Ics	Icu	Ics	Icu	Ics	Icu	Ics	Icu	Ics	Icu	Ics	Icu	Ics	
	0.16	0.1~0.16	100	100	100	100	100	100	100	100	100	100	100	100	100	100	100	100	100	100	100	100	100
	0.25	0.16~0.25	100	100	100	100	100	100	100	100	100	100	100	100	100	100	100	100	100	100	100	100	100
	0.4	0.25~0.4	100	100	100	100	100	100	100	100	100	100	100	100	100	100	100	100	100	100	100	100	100
	0.63	0.4~0.63	100	100	100	100	100	100	100	100	100	100	100	100	100	100	100	100	100	100	100	100	100
	1	0.63~1	100	100	100	100	100	100	100	100	100	100	100	100	100	100	100	100	100	100	100	100	100
	1.6	1~1.6	100	100	100	100	100	100	100	100	100	3	3	100	100	100	100	100	100	100	100	100	100
	2.5	1.6~2.5	100	100	100	100	100	100	100	50	38	3	3	100	100	100	100	100	100	100	100	8	8
	4	2.5~4	100	100	100	100	50	38	15	11	6	5	3	3	100	100	100	100	100	100	100	8	8
	6	4~6	100	100	100	100	15	11	10	8	6	5	3	3	100	100	100	100	100	100	100	6	6
	8	5~8	100	100	100	100	15	11	10	8	6	5	3	3	100	100	100	50	38	50	38	6	6
	10	6~10	100	100	50	38	15	11	6	5	3	3	3	100	100	100	100	50	38	50	38	6	6
	13	9~13	100	100	50	38	10	8	6	5	3	3	3	100	100	100	50	38	42	32	6	6	
	17	11~17	50	38	20	15	10	8	6	5	3	3	3	100	100	50	38	20	15	10	8	4	4
	22	14~22	40	30	15	11	8	6	6	5	3	3	3	100	100	50	38	20	15	10	8	4	4
	26	18~26	40	30	15	11	8	6	5	4	3	3	3	100	100	50	38	20	15	10	8	4	4
	32	22~32	30	22	10	5	6	4	5	4	3	3	3	100	100	50	38	20	15	10	8	4	4
	40	28~40	20	15	10	5	5	3	4	3	2	2	2	100	100	40	30	15	11	8	6	3	3
	50	34~50	-	-	-	-	-	-	-	-	-	-	-	-	-	-	-	-	-	-	-	-	-
	63	45~63	-	-	-	-	-	-	-	-	-	-	-	-	-	-	-	-	-	-	-	-	-
65	47~65	-	-	-	-	-	-	-	-	-	-	-	-	-	-	-	-	-	-	-	-	-	
75	55~75	-	-	-	-	-	-	-	-	-	-	-	-	-	-	-	-	-	-	-	-	-	
90	70~90	-	-	-	-	-	-	-	-	-	-	-	-	-	-	-	-	-	-	-	-	-	
100	80~100	-	-	-	-	-	-	-	-	-	-	-	-	-	-	-	-	-	-	-	-	-	



63AF											100AF																												
MMS-63S					MMS-63H MMS-63HI						MMS-100S					MMS-100H MMS-100HI																							
Standard					High breaking						Standard					High breaking																							
Rotary					Rotary						Rotary					Rotary																							
3					3						3					3																							
Up to 690V					Up to 690V						Up to 690V					Up to 690V																							
50/60 Hz					50/60 Hz						50/60 Hz					50/60 Hz																							
1,000V					1,000V						1,000V					1,000V																							
8kV					8kV						8kV					8kV																							
Cat. A					Cat. A						Cat. A					Cat. A																							
AC 3					AC 3						AC 3					AC 3																							
50,000					50,000						50,000					50,000																							
25,000					25,000						25,000					25,000																							
25					25						25					25																							
-20 ~ +60°C					-20 ~ +60°C						-20 ~ +60°C					-20 ~ +60°C																							
13 × I _e max.					13 × I _e max.						13 × I _e max.					13 × I _e max.																							
o					o						o					o																							
o					o						o					o																							
x					x						o					o																							
o					o						o					o																							
1,000					1,000						2,200					2,200																							
220V 240V 230V	415V 400V	460V 440V	525V 500V	690V 600V	220V 240V 230V	415V 400V	460V 440V	525V 500V	690V 600V	220V 240V 230V	415V 400V	460V 440V	525V 500V	690V 600V	220V 240V 230V	415V 400V	460V 440V	525V 500V	690V 600V																				
I _{cu}	I _{cs}	I _{cu}	I _{cs}	I _{cu}	I _{cs}	I _{cu}	I _{cs}	I _{cu}	I _{cs}	I _{cu}	I _{cs}	I _{cu}	I _{cs}	I _{cu}	I _{cs}	I _{cu}	I _{cs}	I _{cu}	I _{cs}	I _{cu}	I _{cs}	I _{cu}	I _{cs}	I _{cu}	I _{cs}	I _{cu}	I _{cs}	I _{cu}	I _{cs}	I _{cu}	I _{cs}	I _{cu}	I _{cs}	I _{cu}	I _{cs}				
-	-	-	-	-	-	-	-	-	-	-	-	-	-	-	-	-	-	-	-	-	-	-	-	-	-	-	-	-	-	-	-	-	-	-	-	-	-		
-	-	-	-	-	-	-	-	-	-	-	-	-	-	-	-	-	-	-	-	-	-	-	-	-	-	-	-	-	-	-	-	-	-	-	-	-	-	-	
-	-	-	-	-	-	-	-	-	-	-	-	-	-	-	-	-	-	-	-	-	-	-	-	-	-	-	-	-	-	-	-	-	-	-	-	-	-	-	
-	-	-	-	-	-	-	-	-	-	-	-	-	-	-	-	-	-	-	-	-	-	-	-	-	-	-	-	-	-	-	-	-	-	-	-	-	-	-	
-	-	-	-	-	-	-	-	-	-	-	-	-	-	-	-	-	-	-	-	-	-	-	-	-	-	-	-	-	-	-	-	-	-	-	-	-	-	-	
-	-	-	-	-	-	-	-	-	-	-	-	-	-	-	-	-	-	-	-	-	-	-	-	-	-	-	-	-	-	-	-	-	-	-	-	-	-	-	
-	-	-	-	-	-	-	-	-	-	-	-	-	-	-	-	-	-	-	-	-	-	-	-	-	-	-	-	-	-	-	-	-	-	-	-	-	-	-	
-	-	-	-	-	-	-	-	-	-	-	-	-	-	-	-	-	-	-	-	-	-	-	-	-	-	-	-	-	-	-	-	-	-	-	-	-	-	-	
-	-	-	-	-	-	-	-	-	-	-	-	-	-	-	-	-	-	-	-	-	-	-	-	-	-	-	-	-	-	-	-	-	-	-	-	-	-	-	
-	-	-	-	-	-	-	-	-	-	-	-	-	-	-	-	-	-	-	-	-	-	-	-	-	-	-	-	-	-	-	-	-	-	-	-	-	-	-	
-	-	-	-	-	-	-	-	-	-	-	-	-	-	-	-	-	-	-	-	-	-	-	-	-	-	-	-	-	-	-	-	-	-	-	-	-	-	-	
100	100	100	100	15	12	10	8	4	3	100	100	100	100	50	38	50	38	6	5	-	-	-	-	-	-	-	-	-	-	-	-	-	-	-	-	-	-	-	
100	100	50	38	10	8	6	5	4	3	100	100	100	100	50	38	42	32	6	5	-	-	-	-	-	-	-	-	-	-	-	-	-	-	-	-	-	-	-	
100	100	25	19	10	8	6	5	4	3	100	100	50	50	50	38	12	9	5	5	100	100	50	38	40	30	25	19	10	8	100	100	100	100	50	38	35	27	12	9
50	38	25	19	10	8	6	5	4	3	100	100	50	50	50	38	12	9	5	5	100	100	50	38	40	30	25	19	10	8	100	100	100	50	50	38	35	27	12	9
50	38	25	19	10	8	6	5	4	3	100	100	50	50	35	27	12	9	5	5	100	100	50	38	40	30	25	19	10	8	100	100	100	50	50	38	35	27	12	9
50	38	25	19	10	8	6	5	4	3	100	100	50	50	35	27	10	8	5	5	100	100	50	38	40	30	15	11	10	8	100	100	100	50	50	38	25	19	12	9
50	38	25	19	10	8	6	5	4	3	100	100	50	50	35	27	10	8	5	5	100	100	50	38	40	30	15	11	6	5	100	100	100	50	50	38	20	15	12	9
50	38	25	19	10	8	6	5	4	3	100	100	50	50	35	27	10	8	5	5	100	100	50	38	40	30	12	9	6	5	100	100	100	50	50	38	15	11	10	8
50	38	25	19	10	8	6	5	4	3	100	100	50	50	35	27	10	8	5	5	100	100	50	38	40	30	12	9	6	5	100	100	100	50	50	38	15	11	8	6
50	38	25	19	10	8	6	5	4	3	75	50	35	27	25	19	6	5	3	3	-	-	-	-	-	-	-	-	-	-	-	-	-	-	-	-	-	-	-	
-	-	-	-	-	-	-	-	-	-	-	-	-	-	-	-	-	-	-	-	100	100	50	38	40	30	8	6	5	4	100	100	75	50	50	38	12	9	6	6
-	-	-	-	-	-	-	-	-	-	-	-	-	-	-	-	-	-	-	-	100	100	50	38	40	30	8	6	5	4	100	100	75	50	50	38	12	9	6	6
-	-	-	-	-	-	-	-	-	-	-	-	-	-	-	-	-	-	-	-	100	100	50	38	40	30	8	6	5	4	100	100	75	50	50	38	12	9	6	6

Manual Motor Starters

Product Selection Guide

Standard type

- Adjustable thermal release
- Magnetic release 13 le max.
- Trip class 10
- Protective function
 - phase-failure
 - short circuit
 - overload

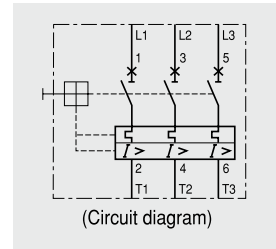

Type	Rated operational current I _e [A]	Thermal release Adjustment range [A]	Magnetic release Operating current [A]	Switching of 3 phase AC motors, AC-2, AC-3						400/415V	
				3-phase [kW] (50/60Hz)			3-phase [HP] (60Hz)			I _{cu} [kA]	I _{cs} [kA]
				230V	400V	690V	230V	460V	575V		
MMS-32S	0.16	0.1...0.16	2.1	-	0.02	-	-	-	-	100	100
	0.25	0.16...0.25	3.3	0.03	0.06	-	-	-	-	100	100
	0.4	0.25...0.4	5.2	0.06	0.09	-	-	-	-	100	100
	0.63	0.4...0.63	8.2	0.09	0.12	0.25	-	-	-	100	100
	1	0.63...1.0	13	0.12	0.25	0.55	-	1/2	1/2	100	100
	1.6	1.0...1.6	20.8	0.25	0.55	1.1	1/3	3/4	1	100	100
	2.5	1.6...2.5	32.5	0.37	0.75	1.5	1/2	1½	1½	100	100
	4	2.5...4.0	52	0.75	1.5	3	1	2	3	100	100
	6	4...6	78	1.5	2.2	4	1½	5	5	100	100
	8	5...8	104	1.5	3	5.5	2	5	5	100	100
	10	6...10	130	3	4	7.5	3	7½	10	50	38
	13	9...13	169	3	5.5	11	3	7½	10	50	38
	17	11...17	221	4	7.5	11	5	10	15	20	15
	22	14...22	286	4	7.5	15	7½	15	20	15	11
MMS-63S	26	18...26	338	5.5	11	18.5	7½	15	20	15	11
	32	22...32	416	7.5	15	22	10	20	30	10	5
	40	28~40	520	7.5	18.5	30	15	30	40	10	5
	10	6~10	130	3	4	7.5	3	7½	10	100	100
	13	9~13	169	3	5.5	11	3	7½	10	50	38
	17	11~17	221	4	7.5	11	5	10	15	25	19
	22	14~22	286	4	7.5	15	7½	15	20	25	19
	26	18~26	338	5.5	11	18.5	10	20	25	25	19
	32	22~32	416	7.5	15	22	10	25	30	25	19
	40	28~40	520	7.5	18.5	30	15	30	40	25	19
MMS-100S	50	34~50	650	11	22	45	15	40	50	25	19
	63	45~63	819	15	30	55	20	50	60	25	19
	65	47~65	845	15	30	55	20	50	60	25	19
	17	11~17	221	4	7.5	11	5	10	15	50	38
	22	14~22	286	4	7.5	15	7½	15	20	50	38
	26	18~26	338	5.5	11	18.5	10	20	25	50	38
	32	22~32	416	7.5	15	22	10	25	30	50	38
	40	28~40	520	7.5	18.5	30	15	30	40	50	38
	50	34~50	650	11	22	45	15	40	50	50	38
	63	45~63	819	15	30	55	20	50	60	50	38
75	55~75	975	22	37	63	25	60	75	50	38	
90	70~90	1170	30	45	75	30	75	100	50	38	
100	80~100	1300	30	45	90	40	75	100	50	38	

High breaking type

- Adjustable thermal release
- Magnetic release 13 le max.
- Trip class 10
- Protective function
 - phase-failure
 - short circuit
 - overload



Type	Rated operational current I_e [A]	Thermal release Adjustment range [A]	Magnetic release Operating current [A]	Switching of 3 phase AC motors, AC-2, AC-3						400/415V	
				3-phase [kW] (50/60Hz)			3-phase [HP] (60Hz)			I_{cu} [kA]	I_{cs} [kA]
				230V	400V	690V	230V	460V	575V		
MMS-32H	0.16	0.1...0.16	2.1	-	0.02	-	-	-	-	100	100
	0.25	0.16...0.25	3.3	0.03	0.06	-	-	-	-	100	100
	0.4	0.25...0.4	5.2	0.06	0.09	-	-	-	-	100	100
	0.63	0.4...0.63	8.2	0.09	0.12	0.25	-	-	-	100	100
	1	0.63...1.0	13	0.12	0.25	0.55	-	1/2	1/2	100	100
	1.6	1.0...1.6	20.8	0.25	0.55	1.1	1/3	3/4	1	100	100
	2.5	1.6...2.5	32.5	0.37	0.75	1.5	1/2	1½	1½	100	100
	4	2.5...4.0	52	0.75	1.5	3	1	2	3	100	100
	6	4...6	78	1.5	2.2	4	1½	5	5	100	100
	8	5...8	104	1.5	3	5.5	2	5	5	100	100
	10	6...10	130	3	4	7.5	3	7½	10	100	100
	13	9...13	169	3	5.5	11	3	7½	10	100	100
	17	11...17	221	4	7.5	11	5	10	15	50	38
	22	14...22	286	4	7.5	15	7½	15	20	50	38
26	18...26	338	5.5	11	18.5	7½	15	20	50	38	
32	22...32	416	7.5	15	22	10	20	30	50	38	
40	28~40	520	7.5	18.5	30	15	30	40	40	30	
MMS-63H	10	6~10	130	3	4	7.5	3	7½	10	100	100
	13	9~13	169	3	5.5	11	3	7½	10	100	100
	17	11~17	221	4	7.5	11	5	10	15	50	50
	22	14~22	286	4	7.5	15	7½	15	20	50	50
	26	18~26	338	5.5	11	18.5	10	20	25	50	50
	32	22~32	416	7.5	15	22	10	25	30	50	50
	40	28~40	520	7.5	18.5	30	15	30	40	50	50
	50	34~50	650	11	22	45	15	40	50	50	50
63	45~63	819	15	30	55	20	50	60	50	50	
65	47~65	845	15	30	55	20	50	60	35	27	
MMS-100H	17	11~17	221	4	7.5	11	5	10	15	100	100
	22	14~22	286	4	7.5	15	7½	15	20	100	50
	26	18~26	338	5.5	11	18.5	10	20	25	100	50
	32	22~32	416	7.5	15	22	10	25	30	100	50
	40	28~40	520	7.5	18.5	30	15	30	40	100	50
	50	34~50	650	11	22	45	15	40	50	100	50
	63	45~63	819	15	30	55	20	50	60	100	50
	75	55~75	975	22	37	63	25	60	75	75	50
90	70~90	1170	30	45	75	30	75	100	75	50	
100	80~100	1300	30	45	90	40	75	100	75	50	

Manual Motor Starters

Product Selection Guide





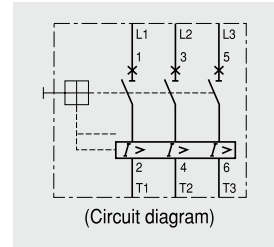

Instantaneous type

- Without thermal releases
- Magnetic release 13 le max.
- Protective function
 - short circuit

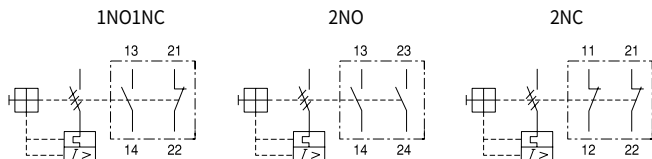

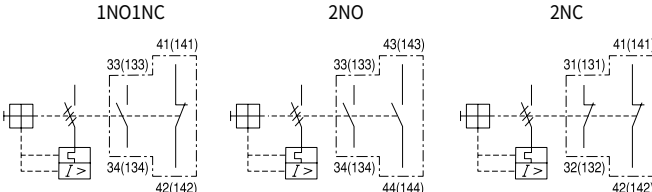
Type	Rated operational current I_e [A]	Thermal release Adjustment range [A]	Magnetic release Operating current [A]	Switching of 3 phase AC motors, AC-2, AC-3						400/415V	
				3-phase [kW] (50/60Hz)			3-phase [HP] (60Hz)			I_{cu} [kA]	I_{cs} [kA]
				230V	400V	690V	230V	460V	575V		
MMS-32HI	0.16	-	2.1	-	0.02	-	-	-	-	100	100
	0.25	-	3.3	0.03	0.06	-	-	-	-	100	100
	0.4	-	5.2	0.06	0.09	-	-	-	-	100	100
	0.63	-	8.2	0.09	0.12	0.25	-	-	-	100	100
	1	-	13	0.12	0.25	0.55	-	1/2	1/2	100	100
	1.6	-	20.8	0.25	0.55	1.1	1/3	3/4	1	100	100
	2.5	-	32.5	0.37	0.75	1.5	1/2	1½	1½	100	100
	4	-	52	0.75	1.5	3	1	2	3	100	100
	6	-	78	1.5	2.2	4	1½	5	5	100	100
	8	-	104	1.5	3	5.5	2	5	5	100	100
	10	-	130	3	4	7.5	3	7½	10	100	100
	13	-	169	3	5.5	11	3	7½	10	100	100
	17	-	221	4	7.5	11	5	10	15	50	38
	22	-	286	4	7.5	15	7½	15	20	50	38
26	-	338	5.5	11	18.5	7½	15	20	50	38	
32	-	416	7.5	15	22	10	20	30	50	38	
40	-	520	7.5	18.5	30	15	30	40	40	30	
MMS-63HI	10	-	130	3	4	7.5	3	7½	10	100	100
	13	-	169	3	5.5	11	3	7½	10	100	100
	17	-	221	4	7.5	11	5	10	15	50	50
	22	-	286	4	7.5	15	7½	15	20	50	50
	26	-	338	5.5	11	18.5	10	20	25	50	50
	32	-	416	7.5	15	22	10	25	30	50	50
	40	-	520	7.5	18.5	30	15	30	40	50	50
	50	-	650	11	22	45	15	40	50	50	50
	63	-	819	15	30	55	20	50	60	50	50
65	-	845	15	30	55	20	50	60	35	27	
MMS-100HI	17	-	221	4	7.5	11	5	10	15	100	100
	22	-	286	4	7.5	15	7½	15	20	100	50
	26	-	338	5.5	11	18.5	10	20	25	100	50
	32	-	416	7.5	15	22	10	25	30	100	50
	40	-	520	7.5	18.5	30	15	30	40	100	50
	50	-	650	11	22	45	15	40	50	100	50
	63	-	819	15	30	55	20	50	60	100	50
	75	-	975	22	37	63	25	60	75	75	50
	90	-	1170	30	45	75	30	75	100	75	50
100	-	1300	30	45	90	40	75	100	75	50	



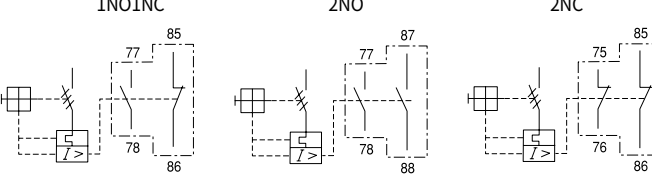

Accessories (Electrical Auxiliaries)

Type	Description	Connection diagram
<p>FX...</p> 	<p>Auxiliary Switch</p> <ul style="list-style-type: none"> • Front mounting • 2-pole • One front mounting module per circuit breaker 	<p>1NO1NC 2NO 2NC</p> 
<p>LX...</p> 	<p>Auxiliary Switch</p> <ul style="list-style-type: none"> • Side mounting on the left • 2-pole • One side mounting module per circuit breaker 	<p>1NO1NC 2NO 2NC</p> 
<p>LA...</p> 	<p>Any Trip Alarm Switch</p> <ul style="list-style-type: none"> • Operates in case of trip • Side mounting on the left • 2-pole • Set LA first in case of using LX together (MMS-63 can not accept LX and LA together) • For MMS-32 and MMS-63/100 products are separated. 	<p>1NO1NC 2NC</p> 
<p>LAM...</p> 	<p>Magnetic Trip Alarm Switch</p> <ul style="list-style-type: none"> • Operates in case of short circuit accidents that is over 20 times of the rated current • Side mounting on the left • 2-pole • Set LAM first in case of using LX together 	<p>1NO1NC 2NO 2NC</p> 

Manual Motor Starters

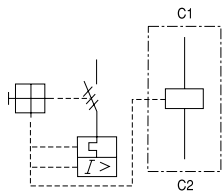
Product Selection Guide

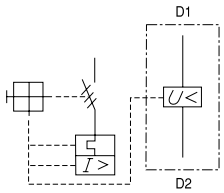
Accessories (Electrical Auxiliaries)

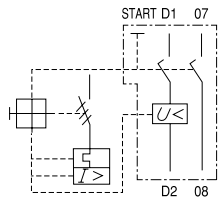
Type	Description	Connection diagram	
RS... 	Shunt release <ul style="list-style-type: none"> Side mounting on the right One side mounting module per circuit breaker. Can not use with RU or RUX 		24V 50Hz / 28V 60Hz 110V 50Hz / 120V 60Hz 200V 50Hz / 200~220V 60Hz 220~230V 50Hz / 240~260V 60Hz 240V 50Hz / 277V 60Hz 380~400V 50Hz / 440~460V 60Hz 415~440V 50Hz / 460~480V 60Hz
RU... 	Undervoltage release <ul style="list-style-type: none"> Side mounting on the right One side mounting module per circuit breaker. Can not use with RU or RUX 		24V 50Hz / 28V 60Hz 110V 50Hz / 120V 60Hz 200V 50Hz / 200~220V 60Hz 220~230V 50Hz / 240~260V 60Hz 240V 50Hz / 277V 60Hz 380~400V 50Hz / 440~460V 60Hz 415~440V 50Hz / 460~480V 60Hz
RUX... 	Undervoltage release with Switch <ul style="list-style-type: none"> Side mounting on the right Include 2NO Auxiliary contact One side mounting module per circuit breaker. Can not use with RU or RUX Can not attach to MMS-32S 		24V 50Hz / 28V 60Hz 110V 50Hz / 120V 60Hz 200V 50Hz / 200~220V 60Hz 220~230V 50Hz / 240~260V 60Hz 240V 50Hz / 277V 60Hz 380~400V 50Hz / 440~460V 60Hz 415~440V 50Hz / 460~480V 60Hz



● E-Handle (Rotary-type)

MMS E-Handle is a Rotary-type Handle accessory which can be attached to the front to control and verify the ON, TRIP, OFF condition of Manual Motor Starters under the situation of closing panel.

- Application Model : MMS-32H/HI, MMS-63S/H/HI, MMS-100S/H/HI
- Operation temp. : -20~ +60°C
- CE and UL certified
- Degree of protection : IP65(UL Type1, Type3R)
- Locking device : Lockable in on/off position
- Material of insulation : Plastic(PA66)

Type	Application MMS	Remarks
MEH-32	MMS-32H, 32HI	Length of shaft : 115 or 315mm
MEH-63	MMS-63S, 63H, 63HI	
MEH-100	MMS-100S, 100H, 100HI	



● Phase Bus System

It is a device for a parallel connection with power terminals in the circuit lined up by MMS, and it can provide the solution “Simple wiring” and “Compact wiring space”.

- Application Model : MMS-32, 63
- CE and UL certified
- Safety Cover built-in
- RoHS compliance

Type	Application MMS	Number of Terminals	Rated current	Safety cover attached
PB-322	MMS-32S, 32H, 32HI	2	63A	PBPC-32
PBL-322	MMS-32S, 32H, 32HI with Aux (LX or LA or LAM)	2		
PB-323	MMS-32S, 32H, 32HI	3		
PBL-323	MMS-32S, 32H, 32HI with Aux (LX or LA or LAM)	3		
PB-324	MMS-32S, 32H, 32HI	4		
PB-325	MMS-32S, 32H, 32HI	5	108A	PBPC-63
PB-632	MMS-63S, 63H, 63HI	2		
PB-633	MMS-63S, 63H, 63HI	3		

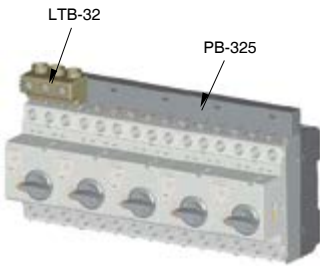

Model	LTB-32
Pole	3P
Mounting location	Upstream
IP degree of protection	IP20 according to IEC 60529
Rated insulation voltage (Ui)	690V according to IEC 60947-1
Rated operational current (Ie)	63A
Terminal torque	1.7 N.m- on screw clamp terminals

● Diagram

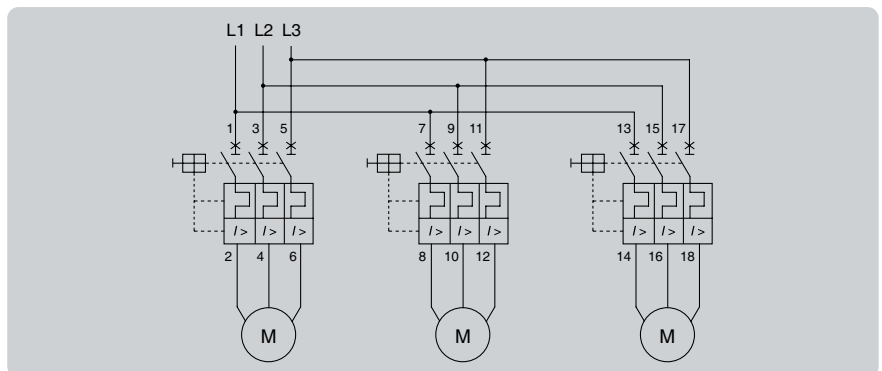

● Terminal Block (TB-32)

It is an accessory device for ensuring the insulation distance between phases. When this device is used, it meets the requirements of UL Combination Motor Controller Type E.

- Application Model : MMS-32H, HI

dItem code	Descriptionddd	Remark
62671941002	TERMINAL ASS'Y,LUG,TB-32	For Type-E self-protected motor controller

Manual Motor Starters

Product Selection Guide

Accessories (Electrical Auxiliaries)



● Enclosure

Case cover of MMS enclosure is specifically designed with dust-proof and corrosive-proof structure.

Therefore, it is the optimum product to use in dusty areas such as cement plants, cotton mills as well as in the presence of corrosive gas or liquid (excl. explosive, flammable gas) such as fertilizer, refinery, and plating plant.

- Application Model: MMS-32H/HI
- Operation temp. : -20~ +60°C
- CE and UL certified
- Degree of protection : IP65
- Material of insulation :Plastic(ABS)

Type	Application MMS	Remarks
EPH-32	MMS-32H, 32HI	Surface mount



● Dial Cover

Dial cover is used to protect the set value from the operation that is not intended.

- Application Model : MMS-32, 63,100 (All types)



● Insulation Barrier

Insulation barrier is used to enlarge the creepage distance and clearance to meet the requirement of UL.

- Application Model : MMS-100

Type	Application MMS
IB100	MMS-100S, 100H, 100HI

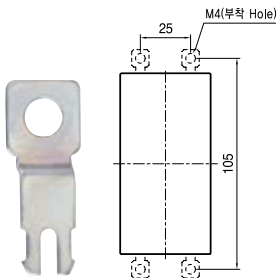

● Screw mounting holder

32AF MMS is only for DIN rail mountable by itself. Screw mounting holder is used to mount MMS on a panel by screws.

- Application Model : MMS-32

Type	Application MMS	Remarks
MP-32	MMS-32S, 32H, 32HI	For M4 screw

● **Direct adaptor and Mounting unit**

Direct adaptor , DA

Direct adaptor is used to connect MMS directly with a contactor

Mounting unit , MU

This device is attached module to connect joined MMS with a contactor

· Application Model : MMS+ Susol, Metasol contactor(MC-9~95, MC-6a~100a), Mini contactor

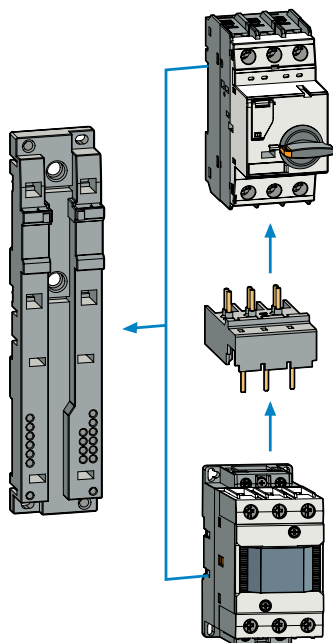

Direct adaptor		Mounting unit	Combined devices	Applying Contactor	
Frame	Name				
DA-16	DA-16SA	MU-45	MMS-32S + GMC-6M~16M	Mini-MC	
	DA-16SD		MMS-32S + GMD-6M~16		
	DA-16HA		MMS-32H + GMC-6M~16M		
	DA-16HD		MMS-32H + GMD-6M~16M		
DA-18	DA-18SA		MMS-32S + MC-6a~18a	Metasol MC	
	DA-18SD		MMS-32S + MC-6a~18a DC		
	DA-18HA		MMS-32H + MC-6a~18a		
	DA-18HD		MMS-32H + MC-6a~18a DC		
DA-22	DA-22SA		MMS-32S + MC-9b~22b		Metasol MC
	DA-22SD		MMS-32S + MC-9b~22b DC		
	DA-22HA		MMS-32H + MC-9b~22b		
	DA-22HD		MMS-32H + MC-9b~22b DC		
DA-32	DA-32SA		MMS-32S + MC-9~32(32a, 40a)	Susol, Metasol MC	
	DA-32SD		MMS-32S + MC-9~32(32a, 40a) DC		
	DA-32HA		MMS-32H + MC-9~32(32a, 40a)		
	DA-32HD		MMS-32H + MC-9~32(32a, 40a) DC		
DA-63	DA-63A	MU-55	MMS-63AF + MC-35~63 (50a, 65a)	Susol, Metasol MC (Lug Type Only)	
	DA-63D		MMS-63AF + MC-35~63 (50a, 65a) DC		
DA-95	DA-95A	MU-70	MMS-100AF + MC-65~95 (75a, 85a, 100a)	Susol, Metasol MC (Lug Type Only)	
	DA-95D		MMS-100AF + MC-65~95 (75a, 85a, 100a) DC		



Note) MMS and Contactor connected with Direct adaptor.

Manual Motor Starters

Technical Information

General data

• Terminals

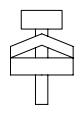
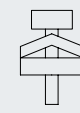
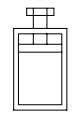
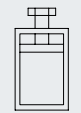
Contents		MMS32S	MMS32H	MMS63S, 63H	MMS100S, 100H
Conformity to standards		IEC60947 UL508, UL508 Type E			
Approvals		CE, UL			
Terminal parts					
Wire					
Single-core	1 conductor	[mm ²] / [AWG]	1...10 / 18...8	0.75...35 / 18...2	2.5...70 / 12...2/0
	2 conductor	[mm ²] / [AWG]	1...6 / 18...10	0.75...25 / 18...4	2.5...50 / 12...1/0
Stranded	1 conductor	[mm ²] / [AWG]	1...6 / 18...10	0.75...35 / 18...2	2.5...70 / 12...2/0
	2 conductor	[mm ²] / [AWG]	1...6 / 18...10	0.75...25 / 18...4	2.5...50 / 12...1/0
Flexible	1 conductor	[mm ²] / [AWG]	1...6 / 18...10	0.75...25 / 18...4	2.5...50 / 12...1/0
	2 conductor	[mm ²] / [AWG]	0.75...4 / 18...10	0.75...16 / 18...6	2.5...35 / 10...2
Tightening torque		[Nm] / [lb-in]	0.8...2.5 / 7...22	3...4.5 / 26...39	4...6 / 35...53

• Power consumption

Contents		MMS32S	MMS32H	MMS63S, 63H	MMS100S, 100H
Total power loss Pv					
Circuit breaker at rated load operating temperature	[W]	In = 0.16~1.6A : 4.4	In = 0.16~1.6A : 4.4	In = 10~22A : 10.2	In = 17~32A : 15
		In = 2.5~26A : 7.4	In = 2.5~26A : 7.4	In = 26~63A : 9.7	In = 40~63A : 21.8
		In = 32A : 4.0	In = 32A : 4.0		In = 75~100A : 17.8

• Mounting

35mm DIN rail for MMS32~63
35mm or 75mm DIN rail for MMS100
- use 15mm depth for 35mm DIN rail

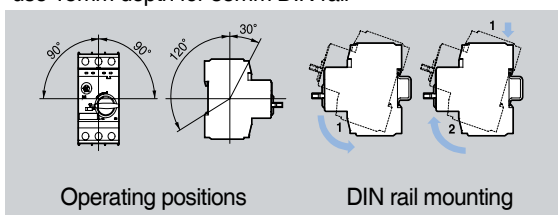

• Caution for thermal adjustments

1. Keep the setting range as shown below.
2. Moving counterclockwise out of the setting range may cause the damage of the device.

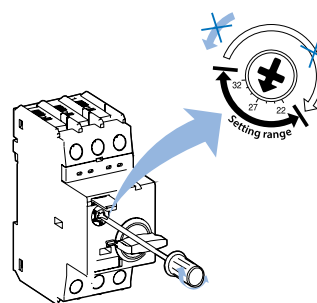

Dial setting method

3. Calibration by ambient air temperature

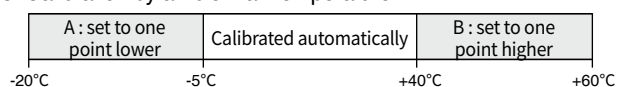

In case of using out of the standard air temperature range(-5°C~+40°C) it needs to be calibrated by one point

● Auxiliaries

Contents		Auxiliary contacts for front mounting FX...	Auxiliary contacts for left side mounting LX...	Alarm switch for left side mounting LA...
Rated thermal current / th				
at 40°C ambient temperature	[A]	5	10	10
at 60°C ambient temperature	[A]	3	6	6
Contact class coordination according to NEMA (UL/CSA-Standards)				
	AC	A600	A600	A600
	DC	Q300	Q300	Q300
Back-up fuses gG, gL		16	16	16
Rated supply current				
	[V]	-	24	24
AC-15:	[A]	-	6	4
DC-13:	[V]	24	220	24
	[A]	1	0.1	2
Weight (g)		18	30	40
Terminal parts				
Wire				
Single-core	1 conductor [mm²] / [AWG]	0.5...2.5 / 20...14		Pozidriv size 2 0.5...2.5 / 20...14
	2 conductor [mm²] / [AWG]	-		0.5...2.5 / 20...14
Stranded	1 conductor [mm²] / [AWG]	0.5...4 / 20...10		0.5...4 / 20...10
	2 conductor [mm²] / [AWG]	0.75...2.5 / 18...14		0.75...2.5 / 18...14
Tightening torque		0.8...1.2 / 7...10		0.8...1.2 / 7...10

Contents		Undervoltage release for right side mounting RU...	Undervoltage release with 2 auxiliary contacts for right side mounting RUX...	Shunt release for right side mounting RS...
Actuating voltage				
Pull-in		0.7...1.1×Us	0.85...1.1×Us	0.85...1.1×Us
Drop-out			0.7...0.35×Us	0.7...0.35×Us
Rated control voltage				
min.:		24V 50Hz / 28V 60Hz	24V 50Hz / 28V 60Hz	24V 50Hz / 28V 60Hz
max.:		415~440V 50Hz / 460~480V 60Hz	415~440V 50Hz / 460~480V 60Hz	415~440V 50Hz / 460~480V 60Hz
Coil rating				
Pull-in		8.5VA, 6W	8.5VA, 6W	8.5VA, 6W
Hold		3VA, 1.2W	3VA, 1.2W	3VA, 1.2W
Opening time (ms)		-	20	20
Weight (g)		18	30	40
Terminal parts				
Wire				
Single-core	1 conductor [mm²] / [AWG]			Pozidriv size 2 0.5...2.5 / 20...14
	2 conductor [mm²] / [AWG]			0.5...2.5 / 20...14
Stranded	1 conductor [mm²] / [AWG]			0.5...4 / 20...10
	2 conductor [mm²] / [AWG]			0.75...2.5 / 18...14
Tightening torque				0.8...1.2 / 7...10

Manual Motor Starters

Technical Information

General data

● Installation of auxiliaries

Be sure to turn off the main switch of MMS before any other action.



MMS-32S/H/Hi

- To install FX remove the cover ① first.
- 2 each of LX can be installed together.
- Only one of auxiliaries among RU, RS and RUX can be mounted on the right side of MMS.
- Do not give trip signal to RS longer than 10 sec.
- Refer to the possible combination chart for the mounting of LX, LA and LAM on left side of MMS.

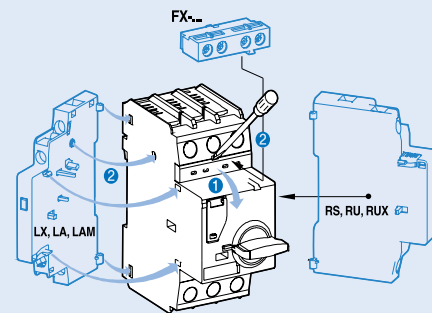

- Push the trip button before installation of LAM

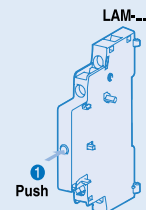

- Remove the indicated part in the fig. before the additional installation of LX

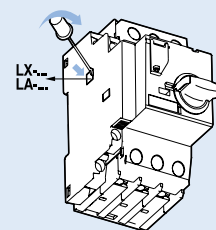

Separation of auxiliaries from MMS

- be sure to turn off the main switch of MMS before the separation.
- push softly the separation button on the side of the auxiliary and pull it.

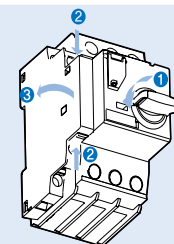

※Please make sure to choose proper LA before use because LA for MMS-32 and MMS-63/100 is different.

MMS-63, 100S/H/HI

- To install FX remove the cover ① first.
- 2 each of LX can be installed together.
(only 1 each for MMS-63)
- Only one of auxiliaries among RU, RS and RUX can be mounted on the right side of MMS.
- Do not give trip signal to RS longer than 10 sec.
- Refer to the possible combination chart for the mounting of LX, LA and LAM on left side of MMS.
- Do not use with LA-... (32)
It is only for MMS-32.

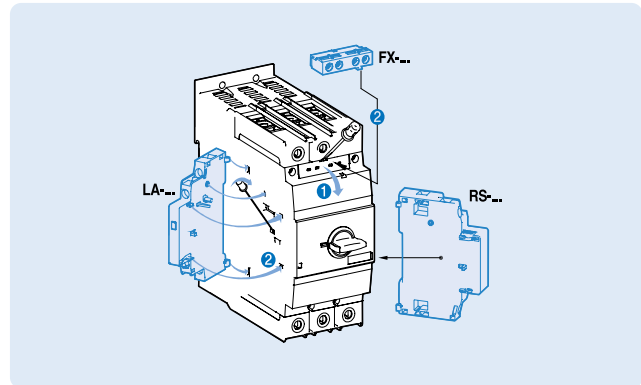

- Push the trip button before installation of LAM

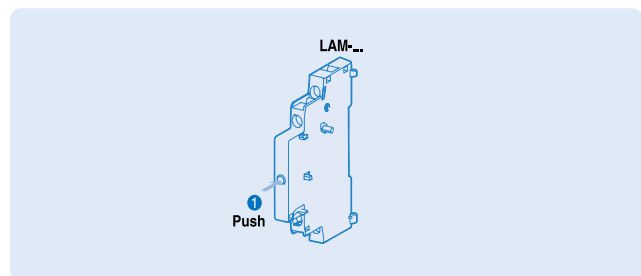

- Do not install LA in the status of TRIP of MMS-100

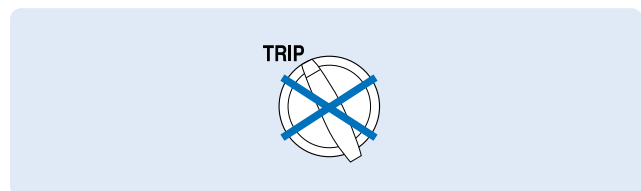

- Remove the indicated part as shown in the above fig. before the additional installation of LX

Separation of auxiliaries from MMS

- be sure to turn off the main switch of MMS before the separation.
- push softly the separation button on the side of the auxiliary and pull it.

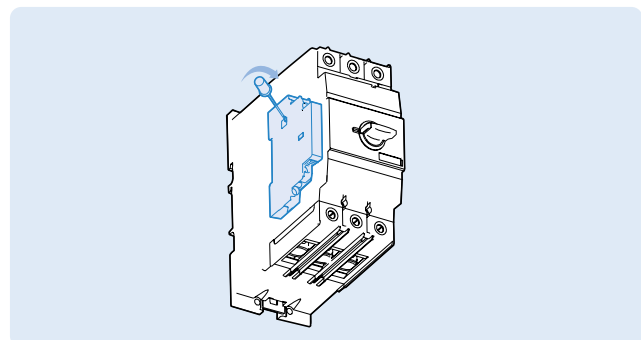

※Please make sure to choose proper LA before use because LA for MMS-32 and MMS-63/100 is different.

Manual Motor Starters

Technical Information

General data

● Installation of auxiliaries

How to Install and reset RUX

Installing

- (1) Check if the trip button of RUX is "UP" .
If not, push the side lever ① to come it up.
- (2) Fit the both lower hooks ② into the MMS.
- (3) Rotate the handle of MMS to the 20 to 30 degree ③ to ON direction and keep it.
- (4) Fit the both upper hooks ④ into the MMS.
- (5) Input power to the RUX.
- (6) Turn ON the handle of MMS.

Resetting

The trip button of RUX does not come "UP" in the event of tripping due to undervoltage.

To turn ON the MMS after the tripping

- ① turn OFF the MMS and check if the trip button of RUX comes "UP" .
- ② push the trip button
- ③ turn ON the MMS

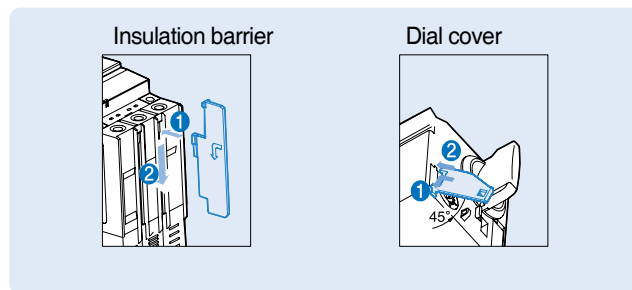
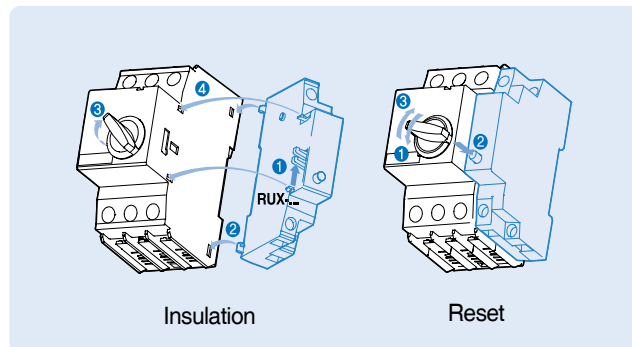

* Only for MMS-100

* For all MMS

Combination with mini contactors

Adaptor	MMS	+ Contactor model
DA-16SA	MMS-32S	+ GMC-6M~16M
DA-16SD	MMS-32S	+ GMD-6M~16M
DA-16HA	MMS-32H, 32HI	+ GMC-6M~16M
DA-16HD	MMS-32H, 32HI	+ GMD-6M~16M
DA-18SA	MMS-32S	+ MC-6a~18a
DA-18SD	MMS-32S	+ MC-6a~18a DC
DA-18HA	MMS-32H	+ MC-6a~18a
DA-18HD	MMS-32H	+ MC-6a~18a DC
DA-22SA	MMS-32S	+ MC-9b~22b
DA-22SD	MMS-32S	+ MC-9b~22b DC
DA-22HA	MMS-32H, 32HI	+ MC-9b~22b
DA-22HD	MMS-32H, 32HI	+ MC-9b~22b DC
DA-32SA	MMS-32S	+ MC-9~32(32a, 40a)
DA-32SD	MMS-32S	+ MC-9~32(32a, 40a) DC
DA-32HA	MMS-32H, 32HI	+ MC-9~32(32a, 40a)
DA-32HD	MMS-32H, 32HI	+ MC-9~32(32a, 40a) DC
DA-63A	MMS-63S, 63H, 63HI	+ MC-35~63(50a, 65a) / Lug Type Only
DA-63D	MMS-63S, 63H, 63HI	+ MC-35~63(50a, 65a) DC / Lug Type Only
DA-95A	MMS-100S, 100H, 100HI	+ MC-65~95(75a, 85a, 100a) / Lug Type Only
DA-95D	MMS-100S, 100H, 100HI	+ MC-65~95(75a, 85a, 100a) DC / Lug Type Only

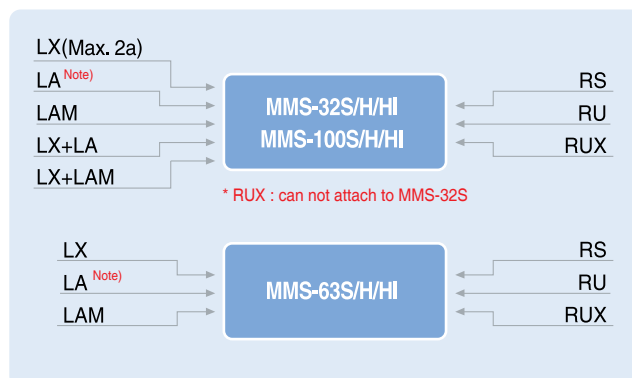
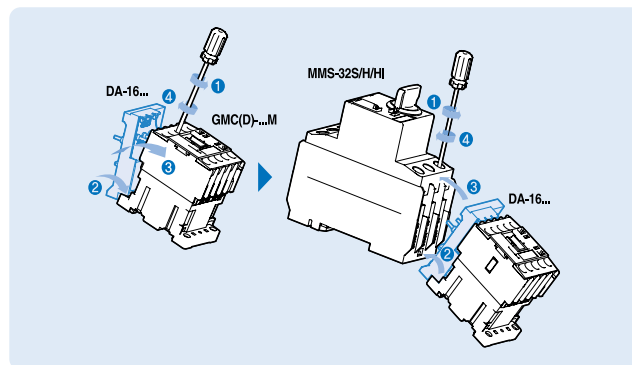

(Note) LA(32 on 63/100 is a sparate).

Possible combination chart

Please read this chart completely before installing the auxiliaries.

Improper combination can cause electric failure or accident.

● E-Handle

Structure

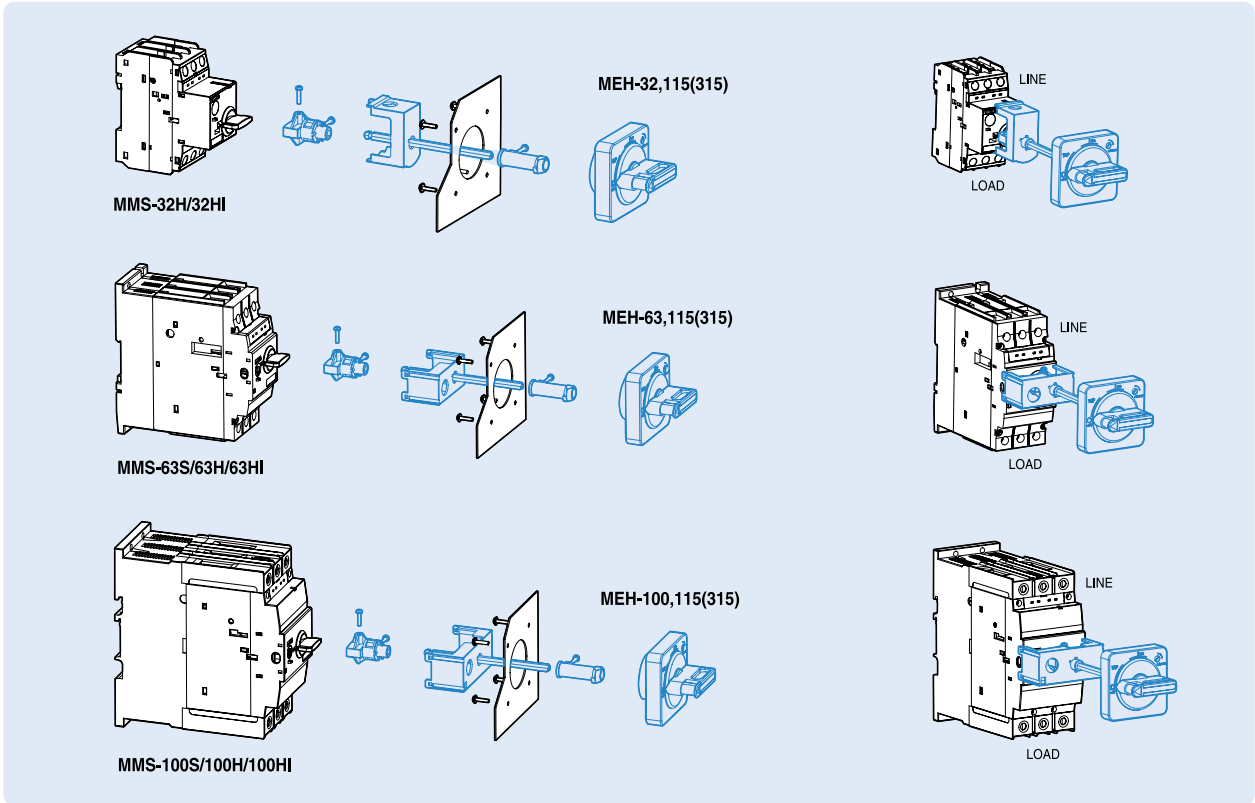

Locking Device

When opening the panel door at ON position

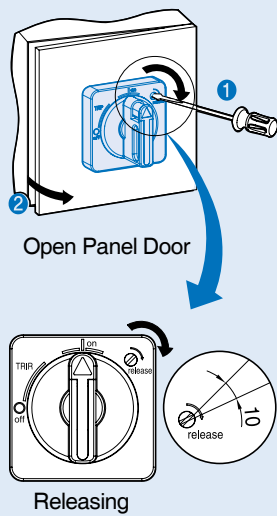

Locking
Installation at OF, OFF position

① Setting to regular position through turning the handle

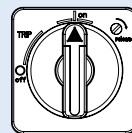

On Position
(Vertical State)

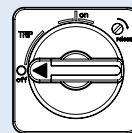

Off Position
(Horizontal State)

② Pushing

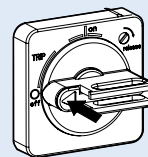

③ Locking

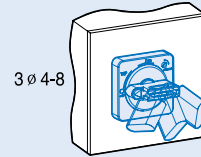

Manual Motor Starters

Technical Information

General data

• E-Handle

Installation

Projection should be passed through the hole when assembling

Projection should be passed through the hole when assembling

MEH-32/63/100

MEH-32

MEH-63/100

MEH-32

MEH-63/100

'Click'

'Click'

'Click'

'Click'

Caution

Restricted fact of Assembling
Assembling is available for MMS-63/100 with 4 holes on the main cover which is produced after June, 2007 based on manufacturing date.

Operating Test

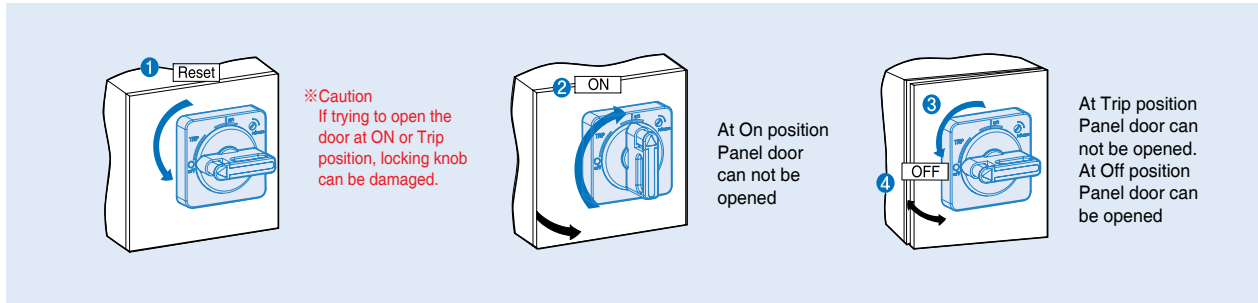

Cutting off the shaft & applying the handle

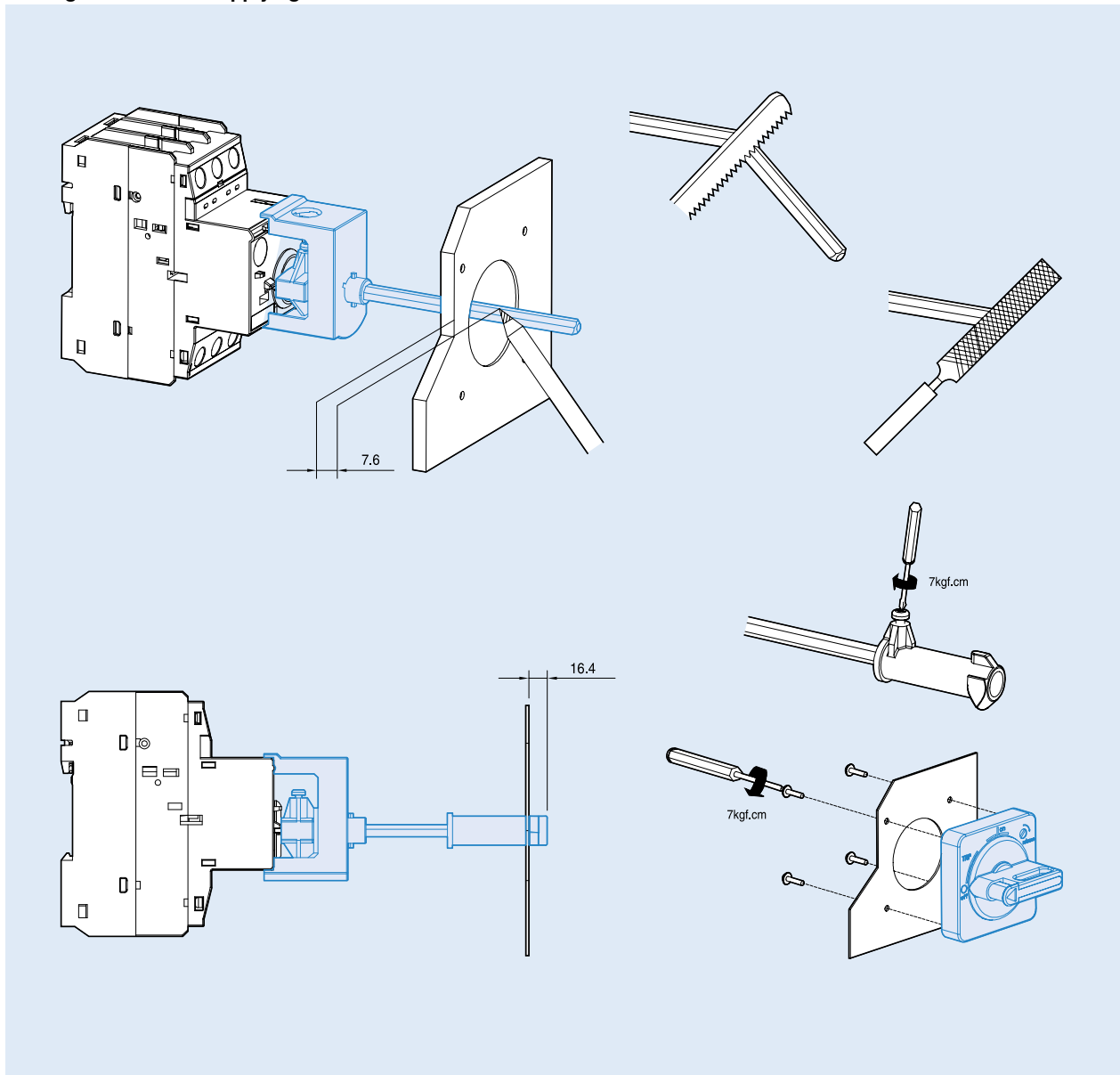

Manual Motor Starters

Technical Information

General data

• Enclosure

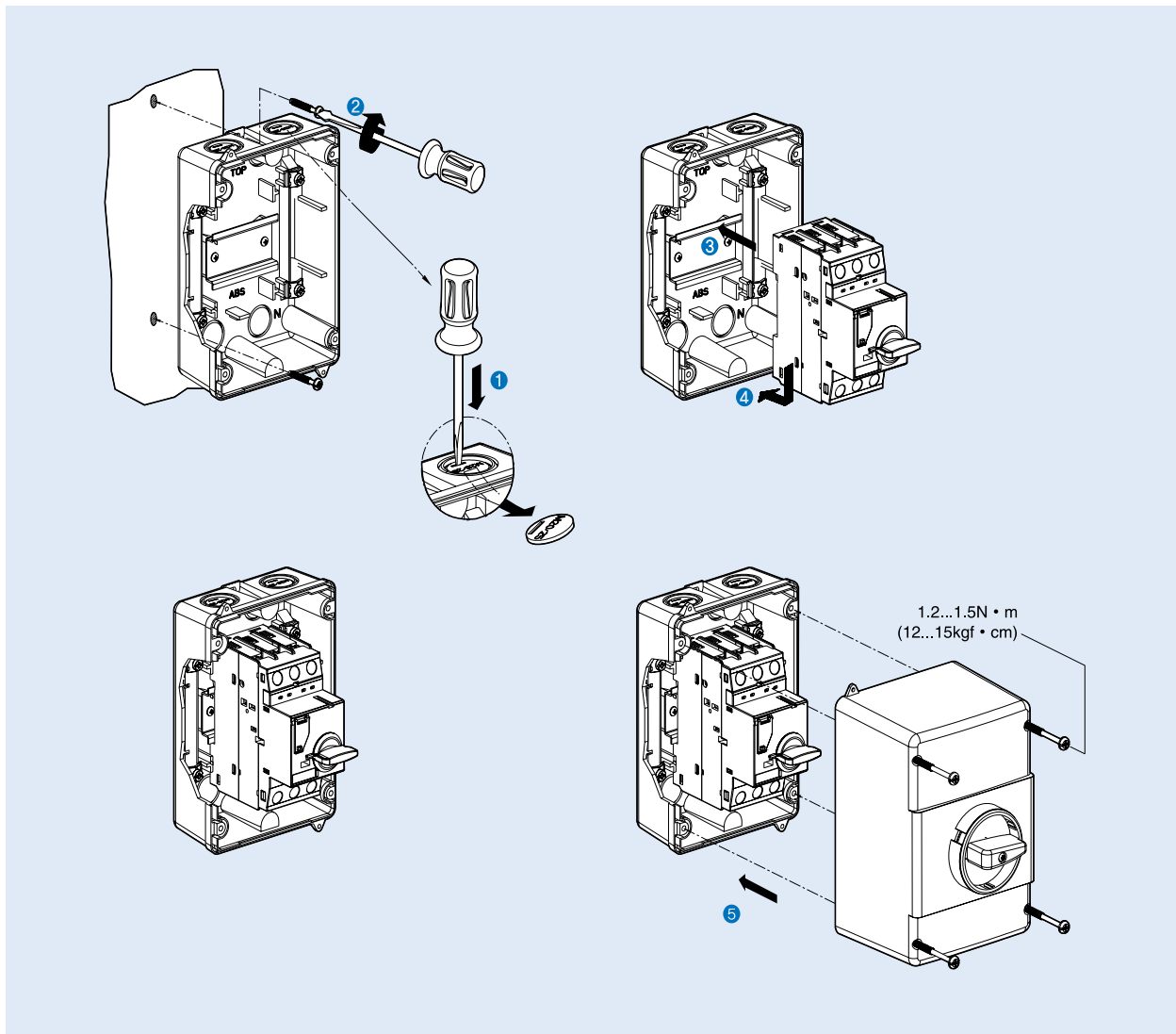

IEC performance data (Motor protection)

Standard type

• MMS 32S

Rated operational current I _e	0.16	0.25	0.4	0.63	1	1.6	2.5	4	6	8	10	13	17	22	26	32	40
Switching of standard three-phase motors																	
AC-2, AC-3																	
230/240V [kW]	-	0.03	0.06	0.09	0.12	0.18/0.25	0.37	0.55/0.75	1.1/1.5	1.5	2.2/3	3	3.7/4	4	5.5	7.5	7.5
400/415V [kW]	0.02	0.06	0.09	0.12	0.18/0.25	0.37/0.55	0.75	1.1/1.5	2.2	3	3.7/4	5.5	7.5	7.5	11	15	18.5
500V [kW]	-	-	-	0.25	0.37	0.55/0.75	1.1	1.5/2.2	3	3.7	4/5.5	7.5	11	11	15	18.5	22
690V [kW]	-	-	-	0.25	0.37/0.55	0.75/1.1	1.5	2.2/3	3.7/4	5.5	7.5	11	11	15	18.5	22	30
Back-up fuses																	
gG, gL ₊ , only if I _{cc} >I _{cu} (* = No back up fuse required)																	
230/240V [kA]	*	*	*	*	*	*	*	*	*	*	*	*	*	125	125	125	160
400/415V [kA]	*	*	*	*	*	*	*	*	*	*	80	80	100	100	100	100	125
440/460V [kA]	*	*	*	*	*	*	50	50	63	63	80	80	100	100	100	100	100
500V [kA]	*	*	*	*	*	*	50	40	50	63	63	80	80	80	80	80	80
690V [kA]	*	*	*	*	*	20	35	40	50	63	63	63	63	63	63	63	63
Ultimate short-circuit breaking capacity I_{cu}																	
230/240V [kA]	100	100	100	100	100	100	100	100	100	100	100	100	50	40	40	30	20
400/415V [kA]	100	100	100	100	100	100	100	100	100	100	50	50	20	15	15	15	10
440/460V [kA]	100	100	100	100	100	100	100	50	15	15	15	10	8	8	8	6	5
500V [kA]	100	100	100	100	100	100	50	15	10	10	6	6	6	6	6	5	4
690V [kA]	100	100	100	100	100	3	3	3	3	3	3	3	3	3	3	3	2
Rated service short-circuit breaking capacity I_{cs}																	
230/240V [kA]	100	100	100	100	100	100	100	100	100	100	100	100	38	30	30	22	15
400/415V [kA]	100	100	100	100	100	100	100	100	100	100	38	38	15	11	11	11	8
440/460V [kA]	100	100	100	100	100	100	100	38	11	11	11	8	8	6	6	4	3
500V [kA]	100	100	100	100	100	100	38	11	8	8	5	5	5	5	5	4	3
690V [kA]	100	100	100	100	100	3	3	3	3	3	3	3	3	3	3	3	2

• MMS 63S

Rated operational current I _e	10	13	17	22	26	32	40	50	63	65
Switching of standard three-phase motors										
AC-2, AC-3										
230/240V [kW]	2.2/3	3	3.7/4	4	5.5	7.5	7.5	11	15	15
400/415V [kW]	3.7/4	5.5	7.5	7.5	11	15	18.5	22	30	30
500V [kW]	4/5.5	7.5	11	11	15	18.5	22	30	37	37
690V [kW]	7.5	11	11	15	18.5	22	30	45	55	55
Back-up fuses										
gG, gL ₊ , only if I _{cc} >I _{cu} (* = No back up fuse required)										
230/240V [kA]	*	*	*	125	125	160	160	160	200	200
400/415V [kA]	*	80	100	125	125	125	125	160	160	180
440/460V [kA]	80	80	100	100	100	100	100	100	125	125
500V [kA]	80	80	80	80	80	80	80	80	80	80
690V [kA]	63	63	63	63	63	63	63	63	80	60
Ultimate short-circuit breaking capacity I_{cu}										
230/240V [kA]	100	100	100	50	50	50	50	50	50	50
400/415V [kA]	100	50	25	25	25	25	25	25	25	25
440/460V [kA]	15	10	10	10	10	10	10	10	10	10
500V [kA]	10	6	6	6	6	6	6	6	6	6
690V [kA]	4	4	4	4	4	4	4	4	4	4
Rated service short-circuit breaking capacity I_{cs}										
230/240V [kA]	100	100	100	38	38	38	38	38	38	38
400/415V [kA]	100	38	19	19	19	19	19	19	19	19
440/460V [kA]	12	8	8	8	8	8	8	8	8	8
500V [kA]	8	5	5	5	5	5	5	5	5	5
690V [kA]	3	3	3	3	3	3	3	3	3	3

Manual Motor Starters

Technical Information

IEC performance data (Motor protection)

Standard type

• MMS 100S

Rated operational current I _e		17	22	26	32	40	50	63	75	90	100
Switching of standard three-phase motors AC-2, AC-3											
230/240V	[kW]	3.7/4	4	5.5	7.5	7.5	11	15	22	30	30
400/415V	[kW]	7.5	7.5	11	15	18.5	22	30	37	45	45
500V	[kW]	11	11	15	18.5	22	30	37	45	55	63
690V	[kW]	11	15	18.5	22	30	45	55	63	75	90
Back-up fuses gG, gL, only if I _{cc} >I _{cu} (* = No back up fuse required)											
230/240V	[kA]	*	*	*	*	*	*	*	*	*	*
400/415V	[kA]	100	125	125	125	160	160	160	160	160	160
440/460V	[kA]	100	125	125	125	125	160	160	160	160	160
500V	[kA]	100	100	100	100	100	100	100	125	125	125
690V	[kA]	63	80	80	80	80	80	80	100	125	125
Ultimate short-circuit breaking capacity I_{cu}											
230/240V	[kA]	100	100	100	100	100	100	100	100	100	100
400/415V	[kA]	50	50	50	50	50	50	50	50	50	50
440/460V	[kA]	40	40	40	40	40	40	40	40	40	40
500V	[kA]	25	25	25	15	15	12	12	8	8	8
690V	[kA]	10	10	10	10	6	6	6	5	5	5
Rated service short-circuit breaking capacity I_{cs}											
230/240V	[kA]	100	100	100	100	100	100	100	100	100	100
400/415V	[kA]	38	38	38	38	38	38	38	38	38	38
440/460V	[kA]	30	30	30	30	30	30	30	30	30	30
500V	[kA]	19	19	19	11	11	9	9	6	6	6
690V	[kA]	8	8	8	8	5	5	5	4	4	4

High breaking type

• MMS 32H

Rated operational current I _e		0.16	0.25	0.4	0.63	1	1.6	2.5	4	6	8	10	13	17	22	26	32	40
Switching of standard three-phase motors AC-2, AC-3																		
230/240V	[kW]	-	0.03	0.06	0.09	0.12	0.18/0.25	0.37	0.55/0.75	1.1/1.5	1.5	2.2/3	3	3.7/4	4	5.5	7.5	7.5
400/415V	[kW]	0.02	0.06	0.09	0.12	0.18/0.25	0.37/0.55	0.75	1.1/1.5	2.2	3	3.7/4	5.5	7.5	7.5	11	15	1.8
500V	[kW]	-	-	-	0.25	0.37	0.55/0.75	1.1	1.5/2.2	3	3.7	4/5.5	7.5	11	11	15	18.5	22
690V	[kW]	-	-	-	0.25	0.37/0.55	0.75/1.1	1.5	2.2/3	3.7/4	5.5	7.5	11	11	15	18.5	22	30
Back-up fuses gG, gL, only if I _{cc} >I _{cu} (* = No back up fuse required)																		
230/240V	[kA]	*	*	*	*	*	*	*	*	*	*	*	*	*	*	*	*	*
400/415V	[kA]	*	*	*	*	*	*	*	*	*	*	*	100	125	125	125	160	
440/460V	[kA]	*	*	*	*	*	*	*	*	80	80	80	80	100	100	100	125	
500V	[kA]	*	*	*	*	*	*	*	*	63	80	80	80	80	80	80	100	
690V	[kA]	*	*	*	*	*	35	40	50	63	63	63	63	63	63	63	80	
Ultimate short-circuit breaking capacity I_{cu}																		
230/240V	[kA]	100	100	100	100	100	100	100	100	100	100	100	100	100	100	100	100	100
400/415V	[kA]	100	100	100	100	100	100	100	100	100	100	100	100	50	50	50	50	40
440/460V	[kA]	100	100	100	100	100	100	100	100	100	50	50	20	20	20	20	20	15
500V	[kA]	100	100	100	100	100	100	100	100	100	50	50	42	10	10	10	10	8
690V	[kA]	100	100	100	100	100	100	8	8	6	6	6	6	4	4	4	4	3
Rated service short-circuit breaking capacity I_{cs}																		
230/240V	[kA]	100	100	100	100	100	100	100	100	100	100	100	100	100	100	100	100	100
400/415V	[kA]	100	100	100	100	100	100	100	100	100	100	100	100	38	38	38	38	30
440/460V	[kA]	100	100	100	100	100	100	100	100	100	38	38	15	15	15	15	15	11
500V	[kA]	100	100	100	100	100	100	100	100	100	38	38	32	8	8	8	8	6
690V	[kA]	100	100	100	100	100	100	8	8	6	6	6	6	4	4	4	4	3

Note) * = Short circuit proof up to 50 or 100kA. No back up fuse required.

High breaking type

● MMS 63H



Rated operational current I_e	10	13	17	22	26	32	40	50	63	65
Switching of standard three-phase motors AC-2, AC-3										
230/240V [kW]	2.2/3	3	3.7/4	4	5.5	7.5	7.5	11	15	15
400/415V [kW]	3.7/4	5.5	7.5	7.5	11	15	18.5	22	30	30
500V [kW]	4/5.5	7.5	11	11	15	18.5	22	30	37	37
690V [kW]	7.5	11	11	15	18.5	22	30	45	55	55
Back-up fuses gG, gL, only if $I_{cc} > I_{cu}$ (* = No back up fuse required)										
230/240V [kA]	*	*	*	*	*	*	*	*	*	*
400/415V [kA]	*	*	100	125	125	125	160	160	160	160
440/460V [kA]	100	100	100	125	125	125	125	125	160	160
500V [kA]	100	100	100	100	100	100	100	100	100	100
690V [kA]	63	63	63	80	80	80	80	80	80	80
Ultimate short-circuit breaking capacity I_{cu}										
230/240V [kA]	100	100	100	100	100	100	100	100	100	75
400/415V [kA]	100	100	50	50	50	50	50	50	50	35
440/460V [kA]	50	50	50	50	35	35	35	35	35	25
500V [kA]	50	42	12	12	12	10	10	10	10	6
690V [kA]	6	6	5	5	5	5	5	5	5	3
Rated service short-circuit breaking capacity I_{cs}										
230/240V [kA]	100	100	100	100	100	100	100	100	100	50
400/415V [kA]	100	100	50	50	50	50	50	50	50	27
440/460V [kA]	38	38	38	38	27	27	27	27	27	19
500V [kA]	38	32	9	9	9	8	8	8	8	5
690V [kA]	5	5	5	5	5	5	5	5	5	3

Note) * = Short circuit proof up to 50 or 100kA. No back up fuse required.

● MMS 100H



Rated operational current I_e	17	22	26	32	40	50	63	75	90	100
Switching of standard three-phase motors AC-2, AC-3										
230/240V [kW]	3.7/4	4	5.5	7.5	7.5	11	15	22	30	30
400/415V [kW]	7.5	7.5	11	15	18.5	22	30	37	45	45
500V [kW]	11	11	15	18.5	22	30	37	45	55	63
690V [kW]	11	15	18.5	22	30	45	55	63	75	90
Back-up fuses gG, gL, only if $I_{cc} > I_{cu}$ (* = No back up fuse required)										
230/240V [kA]	*	*	*	*	*	*	*	*	*	*
400/415V [kA]	*	*	*	*	*	*	*	*	*	*
440/460V [kA]	125	125	125	160	160	160	200	200	200	200
500V [kA]	100	125	125	125	160	160	160	160	160	160
690V [kA]	80	80	80	80	80	100	100	125	160	160
Ultimate short-circuit breaking capacity I_{cu}										
230/240V [kA]	100	100	100	100	100	100	100	100	100	100
400/415V [kA]	100	100	100	100	100	100	100	75	75	75
440/460V [kA]	50	50	50	50	50	50	50	50	50	50
500V [kA]	35	35	35	25	20	15	15	12	12	12
690V [kA]	12	12	12	12	12	10	8	6	6	6
Rated service short-circuit breaking capacity I_{cs}										
230/240V [kA]	100	100	100	100	100	100	100	100	100	100
400/415V [kA]	100	50	50	50	50	50	50	50	50	50
440/460V [kA]	38	38	38	38	38	38	38	38	38	38
500V [kA]	27	27	27	19	15	11	11	9	9	9
690V [kA]	9	9	9	9	9	8	6	6	6	6

Note) * = Short circuit proof up to 50 or 100kA. No back up fuse required.

Manual Motor Starters

Technical Information

IEC performance data (Motor protection)

High breaking type

• MMS 32HI

Rated operational current I _e		0.16	0.25	0.4	0.63	1	1.6	2.5	4	6	8	10	13	17	22	26	32	40	
AC-2, AC-3																			
230/240V	[kW]	-	0.03	0.06	0.09	0.12	0.18/0.25	0.37	0.55/0.75	1.1/1.5	1.5	2.2/3	3	3.7/4	4	5.5	7.5	7.5	
400/415V	[kW]	0.02	0.06	0.09	0.12	0.18/0.25	0.37/0.55	0.75	1.1/1.5	2.2	3	3.7/4	5.5	7.5	7.5	11	15	15	18.5
500V	[kW]	-	-	-	0.25	0.37	0.55/0.75	1.1	1.5/2.2	3	3.7	4/5.5	7.5	11	11	15	18.5	22	
690V	[kW]	-	-	-	0.25	0.37/0.55	0.75/1.1	1.5	2.2/3	3.7/4	5.5	7.5	11	11	15	18.5	22	30	
Back-up fuses gG, gL, only if I _{cc} >I _{cu} (* = No back up fuse required)																			
230/240V	[kA]	*	*	*	*	*	*	*	*	*	*	*	*	*	*	*	*	*	*
400/415V	[kA]	*	*	*	*	*	*	*	*	*	*	*	*	100	125	125	125	160	160
440/460V	[kA]	*	*	*	*	*	*	*	*	*	80	80	80	80	100	100	100	100	125
500V	[kA]	*	*	*	*	*	*	*	*	*	63	80	80	80	80	80	80	80	100
690V	[kA]	*	*	*	*	*	*	35	40	50	63	63	63	63	63	63	63	63	80
Ultimate short-circuit breaking capacity I _{cu}																			
230/240V	[kA]	100	100	100	100	100	100	100	100	100	100	100	100	100	100	100	100	100	100
400/415V	[kA]	100	100	100	100	100	100	100	100	100	100	100	100	100	100	100	100	100	100
440/460V	[kA]	100	100	100	100	100	100	100	100	100	50	50	50	20	20	20	20	15	15
500V	[kA]	100	100	100	100	100	100	100	100	100	50	50	42	10	10	10	10	8	8
690V	[kA]	100	100	100	100	100	100	8	8	6	6	6	6	4	4	4	4	3	3
Rated service short-circuit breaking capacity I _{cs}																			
230/240V	[kA]	100	100	100	100	100	100	100	100	100	100	100	100	100	100	100	100	100	100
400/415V	[kA]	100	100	100	100	100	100	100	100	100	100	100	100	38	38	38	38	38	30
440/460V	[kA]	100	100	100	100	100	100	100	100	100	38	38	38	15	15	15	15	11	11
500V	[kA]	100	100	100	100	100	100	100	100	100	38	38	32	8	8	8	8	6	6
690V	[kA]	100	100	100	100	100	100	8	8	6	6	6	6	4	4	4	4	3	3

• MMS 63HI

Rated operational current I _e		10	13	17	22	26	32	40	50	63	65
AC-2, AC-3											
230/240V	[kW]	2.2/3	3	3.7/4	4	5.5	7.5	7.5	11	15	15
400/415V	[kW]	3.7/4	5.5	7.5	7.5	11	15	18.5	22	30	30
500V	[kW]	4/5.5	7.5	11	11	15	18.5	22	30	37	37
690V	[kW]	7.5	11	11	15	18.5	22	30	45	55	55
Back-up fuses gG, gL, only if I _{cc} >I _{cu} (* = No back up fuse required)											
230/240V	[kA]	*	*	*	*	*	*	*	*	*	*
400/415V	[kA]	*	*	100	125	125	125	160	160	160	160
440/460V	[kA]	100	100	100	125	125	125	125	160	160	160
500V	[kA]	100	100	100	100	100	100	100	100	100	100
690V	[kA]	63	63	63	80	80	80	80	80	80	80
Ultimate short-circuit breaking capacity I _{cu}											
230/240V	[kA]	100	100	100	100	100	100	100	100	100	75
400/415V	[kA]	100	100	50	50	50	50	50	50	50	35
440/460V	[kA]	50	50	50	50	35	35	35	35	35	25
500V	[kA]	50	42	12	12	12	10	10	10	10	6
690V	[kA]	6	6	5	5	5	5	5	5	5	3
Rated service short-circuit breaking capacity I _{cs}											
230/240V	[kA]	100	100	100	100	100	100	100	100	100	50
400/415V	[kA]	100	100	50	50	50	50	50	50	50	27
440/460V	[kA]	38	38	38	38	27	27	27	27	27	19
500V	[kA]	38	32	9	9	9	8	8	8	8	5
690V	[kA]	5	5	5	5	5	5	5	5	5	3

• MMS 100HI

Rated operational current I _e		17	22	26	32	40	50	63	75	90	100
AC-2, AC-3											
230/240V	[kW]	3.7/4	4	5.5	7.5	7.5	11	15	22	30	30
400/415V	[kW]	7.5	7.5	11	15	18.5	22	30	37	45	45
500V	[kW]	11	11	15	18.5	22	30	37	45	55	63
690V	[kW]	11	15	18.5	22	30	45	55	63	75	90
Back-up fuses gG, gL, only if I _{cc} >I _{cu} (* = No back up fuse required)											
230/240V	[kA]	*	*	*	*	*	*	*	*	*	*
400/415V	[kA]	*	*	*	*	*	*	*	*	*	*
440/460V	[kA]	125	125	125	160	160	200	200	200	200	200
500V	[kA]	100	125	125	125	160	160	160	160	160	160
690V	[kA]	80	80	80	80	80	100	100	125	160	160
Ultimate short-circuit breaking capacity I _{cu}											
230/240V	[kA]	100	100	100	100	100	100	100	100	100	100
400/415V	[kA]	100	100	100	100	100	100	100	75	75	75
440/460V	[kA]	50	50	50	50	50	50	50	50	50	50
500V	[kA]	35	35	35	25	20	15	15	12	12	12
690V	[kA]	12	12	12	12	12	10	8	6	6	6
Rated service short-circuit breaking capacity I _{cs}											
230/240V	[kA]	100	100	100	100	100	100	100	100	100	100
400/415V	[kA]	100	50	50	50	50	50	50	50	50	50
440/460V	[kA]	38	38	38	38	38	38	38	38	38	38
500V	[kA]	27	27	27	19	15	11	11	9	9	9
690V	[kA]	9	9	9	9	9	8	6	6	6	6

Manual motor controller (UL 508, CSA C22.2 as Manual motor controllers)

Combination Motor Controller

- Group Installation

- Type E starter

• MMS 32S

Rated operational current I _e		0.16	0.25	0.4	0.63	1	1.6	2.5	4	6	8	10	13	17	22	26	32	40	
Max. short-circuit current																			
240V	[kA]	100	100	100	100	100	100	100	100	100	100	50	50	40	30	30	20	20	
480V	[kA]	50	50	50	50	50	50	50	50	25	25	10	10	10	10	7.5	7.5	7.5	
600V	[kA]	10	10	10	10	10	10	10	5	5	5	5	5	5	5	5	5	5	
Motor load																			
1 Phase	115V	[HP]	-	-	-	-	-	-	1/8	1/4	1/3	1/2	1/2	1	1½	2	2	3	
	230V	[HP]	-	-	-	-	1/10	1/6	1/3	1/2	1	1½	2	3	3	3	5	7½	
3 Phase	200V	[HP]	-	-	-	-	-	1/2	3/4	1	2	2	3	3	5	7½	7½	10	
	230V	[HP]	-	-	-	-	-	1/2	3/4	1½	2	3	3	5	7½	7½	10	10	
	460V	[HP]	-	-	-	-	3/4	1	2	3	5	5	7½	10	15	15	20	30	
	575V	[HP]	-	-	-	-	1/2	3/4	1½	3	5	5	7½	10	15	20	30	30	
Max. fuse size		[A]	1	1	1	1	3	6	10	15	20	30	40	50	60	80	100	125	125
Max. breaker size		[A]	15	15	15	15	15	15	15	20	30	40	50	60	80	100	125	125	

• MMS 63S

Rated operational current I _e		10	13	17	22	26	32	40	50	63	65
Max. short-circuit current											
240V	[kA]	100	100	100	100	100	100	100	100	100	100
480V	[kA]	50	50	40	40	40	40	40	40	40	40
600V	[kA]	10	10	10	10	10	10	10	10	10	10
Motor load											
1 Phase	115V	[HP]	1/2	1/2	1	1½	2	2	3	3	5
	230V	[HP]	1½	2	3	3	3	5	7½	10	10
3 Phase	200V	[HP]	2	3	3	5	7½	7½	10	15	20
	230V	[HP]	3	3	5	7½	7½	10	10	15	20
	460V	[HP]	5	7½	10	15	15	20	30	30	40
	575V	[HP]	7½	10	15	20	20	30	30	40	60
Maximum rated current of fuse or breaker		[A]	600	600	600	600	600	600	600	600	600

• MMS 100S

Rated operational current I _e		17	22	26	32	40	50	63	75	90	100
Max. short-circuit current											
240V	[kA]	100	100	100	100	100	100	100	100	100	100
480V	[kA]	50	50	50	50	50	50	40	40	40	40
600V	[kA]	10	10	10	10	10	10	10	10	10	10
Motor load											
1 Phase	115V	[HP]	1	1½	2	2	3	3	5	5	7½
	230V	[HP]	3	3	3	5	7½	10	10	15	20
3 Phase	200V	[HP]	3	5	7½	7½	10	15	20	20	25
	230V	[HP]	5	7½	7½	10	10	15	20	25	30
	460V	[HP]	10	15	15	20	30	30	40	50	60
	575V	[HP]	15	20	20	30	30	40	60	60	75
Maximum rated current of fuse or breaker		[A]	1000	1000	1000	1000	1000	1000	1000	1000	1000

In case of 1-phase use in series as shown below

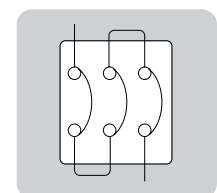

Manual Motor Starters

Technical Information

Manual motor controller (UL 508, CSA C22.2 as Manual motor controllers)

Combination Motor Controller

- Group Installation

- Type E starter

● MMS 32H

Rated operational current I _e			0.16	0.25	0.4	0.63	1	1.6	2.5	4	6	8	10	13	17	22	26	32	40		
Max. short-circuit current																					
240V	[kA]		100	100	100	100	100	100	100	100	100	100	100	100	100	100	100	100	100	100	
480V	[kA]		65	65	65	65	65	65	65	65	65	65	65	65	30	30	30	30	30	30	
600V	[kA]		25	25	25	25	25	25	25	25	25	25	25	25	10	10	10	10	10	10	
Motor load																					
1 Phase	115V	[HP]	-	-	-	-	-	-	-	1/8	1/4	1/3	1/2	1/2	1	1½	2	2	3		
	230V	[HP]	-	-	-	-	-	1/10	1/6	1/3	1/2	1	1½	2	3	3	3	5	7½		
3 Phase	200V	[HP]	-	-	-	-	-	-	1/2	3/4	1	2	2	3	3	5	7½	7½	10	10	
	230V	[HP]	-	-	-	-	-	-	1/2	3/4	1½	2	3	3	5	7½	7½	10	10	10	
	460V	[HP]	-	-	-	-	-	3/4	1	2	3	5	5	7½	10	15	15	20	30	30	
	575V	[HP]	-	-	-	-	1/2	3/4	1½	3	5	5	7½	10	15	20	20	30	30	30	
Maximum rated current of fuse or breaker			[A]	500	500	500	500	500	500	500	500	500	500	500	500	500	500	500	500	500	500

● MMS 63H

Rated operational current I _e			10	13	17	22	26	32	40	50	63	65
Max. short-circuit current												
240V	[kA]		100	100	100	100	100	100	100	100	100	100
480V	[kA]		65	65	50	50	50	50	50	50	50	50
600V	[kA]		25	25	10	10	10	10	10	10	10	10
Motor load												
1 Phase	115V	[HP]	1/2	1/2	1	1½	2	2	3	3	5	5
	230V	[HP]	1½	2	3	3	3	5	7½	10	10	10
3 Phase	200V	[HP]	2	3	3	5	7½	7½	10	15	20	20
	230V	[HP]	3	3	5	7½	7½	10	10	15	20	20
	460V	[HP]	5	7½	10	15	15	20	30	30	40	40
	575V	[HP]	7½	10	15	20	20	30	30	40	60	60
Maximum rated current of fuse or breaker			[A]	600	600	600	600	600	600	600	600	600

● MMS 100H

Rated operational current I _e			17	22	26	32	40	50	63	75	90	100
Max. short-circuit current												
240V	[kA]		100	100	100	100	100	100	100	100	100	100
480V	[kA]		65	65	65	65	65	65	50	50	50	50
600V	[kA]		25	25	25	20	20	20	10	10	10	10
Motor load												
1 Phase	115V	[HP]	1	1½	2	2	3	3	5	5	7½	10
	230V	[HP]	3	3	3	5	7½	10	10	15	20	20
3 Phase	200V	[HP]	3	5	7½	7½	10	15	20	20	25	30
	230V	[HP]	5	7½	7½	10	10	15	20	25	30	30
	460V	[HP]	10	15	15	20	30	30	40	50	60	75
	575V	[HP]	15	20	20	30	30	40	60	60	75	100
Maximum rated current of fuse or breaker			[A]	1000	1000	1000	1000	1000	1000	1000	1000	1000

In case of 1-phase use in series as shown below

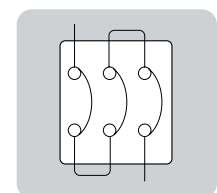

Manual Motor Controller (UL508)

• MMS 32S

Rated operational current I _e		0.16	0.25	0.4	0.63	1	1.6	2.5	4	6	8	10	13	17	22	26	32	40	
Max. short-circuit current																			
240V	[kA]	100	100	100	100	100	100	100	100	100	100	50	50	40	30	30	20	20	
480V	[kA]	50	50	50	50	50	50	50	50	25	25	10	10	10	10	7.5	7.5	7.5	
600V	[kA]	10	10	10	10	10	10	10	5	5	5	5	5	5	5	5	5	5	
Motor load																			
1 Phase	115V	[HP]	-	-	-	-	-	-	1/8	1/4	1/3	1/2	1/2	1	1½	2	2	3	
	230V	[HP]	-	-	-	-	1/10	1/6	1/3	1/2	1	1½	2	3	3	3	5	7½	
3 Phase	200V	[HP]	-	-	-	-	-	1/2	3/4	1	2	2	3	3	5	7½	7½	10	
	230V	[HP]	-	-	-	-	-	1/2	3/4	1½	2	3	3	5	7½	7½	10	10	
	460V	[HP]	-	-	-	-	3/4	1	2	3	5	5	7½	10	15	15	20	30	
	575V	[HP]	-	-	-	-	1/2	3/4	1½	3	5	5	7½	10	15	20	30	30	
Max. fuse size	[A]	1	1	1	1	3	6	10	15	20	30	40	50	60	80	100	125	150	
Max. breaker size	[A]	15	15	15	15	15	15	15	15	20	30	40	50	60	80	100	125	150	

• MMS 63S

Rated operational current I _e		10	13	17	22	26	32	40	50	63	65
Max. short-circuit current											
240V	[kA]	100	100	100	100	100	100	100	100	100	100
480V	[kA]	25	25	25	25	25	25	25	25	25	25
600V	[kA]	10	10	10	10	10	10	10	10	10	10
Motor load											
1 Phase	115V	[HP]	1/2	1/2	1	1½	2	2	3	3	5
	230V	[HP]	1½	2	3	3	3	5	7½	10	10
3 Phase	200V	[HP]	2	3	3	5	7½	7½	10	15	20
	230V	[HP]	3	3	5	7½	7½	10	10	15	20
	460V	[HP]	5	7½	10	15	15	20	30	30	40
	575V	[HP]	7½	10	15	20	20	30	30	40	60
Max. fuse size	[A]	40	50	60	80	100	125	150	200	250	250
Max. breaker size	[A]	40	50	60	80	100	125	150	200	250	250

• MMS 100S

Rated operational current I _e		17	22	26	32	40	50	63	75	90	100
Max. short-circuit current											
240V	[kA]	100	100	100	100	100	100	100	100	100	100
480V	[kA]	25	25	25	25	25	25	25	25	25	25
600V	[kA]	10	10	10	10	10	10	10	10	10	10
Motor load											
1 Phase	115V	[HP]	1	1½	2	2	3	3	5	5	7½
	230V	[HP]	3	3	3	5	7½	10	10	15	20
3 Phase	200V	[HP]	3	5	7½	7½	10	15	20	20	25
3 Phase	230V	[HP]	5	7½	7½	10	10	15	20	25	30
	460V	[HP]	10	15	15	20	30	30	40	50	75
	575V	[HP]	15	20	20	30	30	40	60	60	75
Max. fuse size	[A]	60	80	100	125	150	200	250	300	350	400
Max. breaker size	[A]	60	80	100	125	150	200	250	300	350	400

In case of 1-phase use in series as shown below

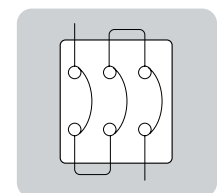

Manual Motor Starters

Technical Information

Manual Motor Controller (UL508)

• MMS 32H

Rated operational current I _e			0.16	0.25	0.4	0.63	1	1.6	2.5	4	6	8	10	13	17	22	26	32	40	
Max. short-circuit current																				
	240V	[kA]	100	100	100	100	100	100	100	100	100	100	100	100	100	100	100	100	100	100
	480V	[kA]	50	50	50	50	50	50	50	50	50	50	50	50	30	30	30	30	30	30
	600V	[kA]	10	10	10	10	10	10	10	10	10	10	10	10	10	10	10	10	10	10
Motor load																				
1 Phase	115V	[HP]	-	-	-	-	-	-	-	1/8	1/4	1/3	1/2	1/2	1	1½	2	2	3	
	230V	[HP]	-	-	-	-	-	1/10	1/6	1/3	1/2	1	1½	2	3	3	3	5	7½	
3 Phase	200V	[HP]	-	-	-	-	-	-	1/2	3/4	1	2	2	3	3	5	7½	7½	10	
	230V	[HP]	-	-	-	-	-	-	1/2	3/4	1½	2	3	3	5	7½	7½	10	10	
	460V	[HP]	-	-	-	-	-	3/4	1	2	3	5	5	7½	10	15	15	20	30	
	575V	[HP]	-	-	-	-	1/2	3/4	1½	3	5	5	7½	10	15	20	20	30	30	
Max. fuse size			[A]	1	1	1	1	3	6	10	15	20	30	40	50	60	80	100	125	150
Max. breaker size			[A]	15	15	15	15	15	15	15	15	20	30	40	50	60	80	100	125	150

• MMS 63H

Rated operational current I _e			10	13	17	22	26	32	40	50	63	65
Max. short-circuit current												
	240V	[kA]	100	100	100	100	100	100	100	100	100	100
	480V	[kA]	50	50	50	50	50	50	50	50	50	50
	600V	[kA]	10	10	10	10	10	10	10	10	10	10
Motor load												
1 Phase	115V	[HP]	1/2	1/2	1	1½	2	2	3	3	5	5
	230V	[HP]	1½	2	3	3	3	5	7½	10	10	10
3 Phase	200V	[HP]	2	3	3	5	7½	7½	10	15	20	20
	230V	[HP]	3	3	5	7½	7½	10	10	15	20	20
	460V	[HP]	5	7½	10	15	15	20	30	30	40	40
	575V	[HP]	7½	10	15	20	20	30	30	40	60	60
Max. fuse size			[A]	40	50	60	80	100	125	150	200	250
Max. breaker size			[A]	40	50	60	80	100	125	150	200	250

• MMS 100H

Rated operational current I _e			17	22	26	32	40	50	63	75	90	100
Max. short-circuit current												
	240V	[kA]	100	100	100	100	100	100	100	100	100	100
	480V	[kA]	50	50	50	50	50	50	50	50	50	50
	600V	[kA]	10	10	10	10	10	10	10	10	10	10
Motor load												
1 Phase	115V	[HP]	1	1½	2	2	3	3	5	5	7½	10
	230V	[HP]	3	3	3	5	7½	10	10	15	20	20
3 Phase	200V	[HP]	3	5	7½	7½	10	15	20	20	25	30
	230V	[HP]	5	7½	7½	10	10	15	20	25	30	30
	460V	[HP]	10	15	15	20	30	30	40	50	60	75
	575V	[HP]	15	20	20	30	30	40	60	60	75	100
Max. fuse size			[A]	60	80	100	125	150	200	250	300	400
Max. breaker size			[A]	60	80	100	125	150	200	250	300	400

In case of 1-phase use in series as shown below

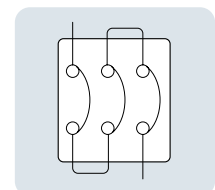

Type '2' coordination according to IEC60947-4-1

- Short-circuit current $I_q = 50\text{kA}$
Voltage : 400/415V, 50/60Hz

Standard motors AC-3 at 400/415V 1500rpm		Manual motor starter			Contactor	
		Circuit breaker	Thermal overload release setting range	Magnetic release response current		
[kW]	[A]	Type	[A]	[A]	Type	[A]
-	-	MMS-32S 0.16A	0.1~0.16	2.1	GMC-6M / MC-9a / MC-9b	6 / 9
0.06	0.2	MMS-32S 0.25A	0.16~0.25	3.3	GMC-6M / MC-9a / MC-9b	6 / 9
0.09	0.3	MMS-32S 0.4A	0.25~0.4	5.2	GMC-6M / MC-9a / MC-9b	6 / 9
0.12	0.4	MMS-32S 0.63A	0.4~0.63	8.2	GMC-6M / MC-9a / MC-9b	6 / 9
0.18	0.6	MMS-32S 1A	0.63~1	13	GMC-6M / MC-9a / MC-9b	6 / 9
0.25	0.8	MMS-32S 1A	0.63~1	13	GMC-6M / MC-9a / MC-9b	6 / 9
0.37	1.1	MMS-32S 1.6A	1~1.6	20.8	GMC-6M / MC-9a / MC-9b	6 / 9
0.55	1.5	MMS-32S 1.6A	1~1.6	20.8	GMC-6M / MC-9a / MC-9b	6 / 9
0.75	1.9	MMS-32S 2.5A	1.6~2.5	32.5	MC-12a / MC-12b	12
1.1	2.7	MMS-32S 4A	2.5~4	52	MC-18a / MC-18b	18
1.5	3.6	MMS-32S 4A	2.5~4	52	MC-18a / MC-18b	18
2.2	5.2	MMS-32S 6A	4~6	78	MC-18a / MC-18b	18
3	6.8	MMS-32S 8A	5~8	104	MC-18a / MC-18b	18
4	9	MMS-32S 10A	6~10	130	MC-18a / MC-18b	18
5.5	11.5	MMS-32H 13A	9~13	169	MC-22b	22
7.5	15.5	MMS-32H 17A	11~17	221	MC-22b	22
10	20	MMS-32H 22A	14~22	286	MC-32a	32
11	22	MMS-32H 26A	18~26	338	MC-32a	32
15	29	MMS-32H 32A	22~32	416	MC-32a	32
18.5	35	MMS-63H 40A	28~40	520	MC-40a	40
22	41	MMS-63H 50A	34~50	650	MC-50a	50
30	55	MMS-63H 63A	45~63	819	MC-65a	65
37	67	MMS-100S 75A	55~75	975	MC-75a	75
-	-	MMS-100S 90A	70~90	1170	MC-85a	85
45	80	MMS-100S 100A	80~100	1300	MC-85a	85

Definition type '2' coordination according to IEC 60947-4-1 :

- The contactor or the starter must not endanger persons or systems in the event of a short-circuit.
- The contactor or the starter must be suitable for further use.
- No damage to the overload relay or other parts may occur with the exception of welding of the contactor or starter contacts provided that these can be easily separated without significant deformation (such as with a screwdriver).

Manual Motor Starters

Technical Information

IE3-rated motor

• LS MMS ready for IE3-rated motors

Type	Rated Current(A)	Short-circuit Current(A)	Current Range(A)			Short-circuit Current ratio		
			Min	Mid	Max	Min	Mid	Max
32	0.16A	2.1	0.1	0.13	0.16	20.8	16.0	13.0
	0.25A	3.3	0.16	0.2	0.25	20.3	16.3	13.0
	0.4A	5.2	0.25	0.33	0.4	20.8	15.8	13.0
	0.63A	8.2	0.4	0.52	0.63	20.5	15.8	13.0
	1A	13.0	0.63	0.81	1	20.6	16.0	13.0
	1.6A	20.8	1	1.3	1.6	20.8	16.0	13.0
	2.5A	32.5	1.6	2.1	2.5	20.3	15.5	13.0
	4A	52	2.5	3.3	4	20.8	15.8	13.0
	6A	78	4	5	6	19.5	15.6	13.0
	8A	104	5	6.5	8	20.8	16.0	13.0
	10A	130	6	8	10	21.7	16.3	13.0
	13A	169	9	11	13	18.8	15.4	13.0
	17A	221	11	14	17	20.1	15.8	13.0
	22A	286	14	18	22	20.4	15.9	13.0
	26A	338	18	22	26	18.8	15.4	13.0
32A	416	22	27	32	18.9	15.4	13.0	
40A	520	28	34	40	18.6	15.3	13.0	
63	10A	130	6	8	10	21.7	16.3	13.0
	13A	169	9	11	13	18.8	15.4	13.0
	17A	221	11	14	17	20.1	15.8	13.0
	22A	286	14	17	22	20.4	16.8	13.0
	26A	338	18	22	26	18.8	15.4	13.0
	32A	416	22	27	32	18.9	15.4	13.0
	40A	520	28	34	40	18.6	15.3	13.0
	50A	650	34	42	50	19.1	15.5	13.0
	63A	819	45	54	63	18.2	15.2	13.0
65A	845	47	56	65	18.0	15.1	13.0	
100	17A	221	11	14	17	20.1	15.8	13.0
	22A	286	14	18	22	20.4	15.9	13.0
	26A	338	18	22	26	18.8	15.4	13.0
	32A	416	22	27	32	18.9	15.4	13.0
	40A	520	28	34	40	18.6	15.3	13.0
	50A	650	34	42	50	19.1	15.5	13.0
	63A	819	45	54	63	18.2	15.2	13.0
	75A	975	55	65	75	17.7	15.0	13.0
	90A	1170	70	80	90	16.7	14.6	13.0
	100A	1300	80	90	100	16.3	14.4	13.0



• What is the IE3?

Motor is rated from IE1 through IE4 depends on its energy efficiency which means IE3 is more efficient compared to IE1 and IE2-rated motors.



• Why IE3?

As part of the EU Environmental policy "20/30-20-20" strategy, the EU is committed to achieve the followings by 2020.

- Reduce greenhouse gas emissions by up to 30 %
- Increase the share of renewable energy to 20 % and
- Boost energy efficiency by 20% in general.

IEC 60034-30 standard specifies IE classes for motors in accordance with the above requirements.

Therefore, consumers must comply with the standard when using MMS products.



- IEC 60034-30-1 standard
- IE1 Standard Efficiency
- IE2 High Efficiency
- **IE3 Premium Efficiency**
- IE4 Super Premium Efficiency

• How to select MMS?

To meet the IE3 motor starting current & Inrush current, use of de-rating table is recommended. (13 times the rated current)

Example)

If you select the product A or B...

A : MMS setting scale " 11 ~ 17A

B : MMS setting scale " 14 ~ 22A

Rated motor Current : 16A



The short-circuit current of MMS A is 221A (17*13), and MMS B is 286A (22*13).

When applying the motor's rated current(16A) to MMS A, the multiplier of the short-circuit current is 13.8 times. When applying the motor's rated current(16A) to MMS B, the multiplier of the short-circuit current is 17.9 times. If motor of IE3-grade or above is used here, malfunction can be caused due to higher starting current compared to that of IE1,2-graded motor. Therefore, MMS B is recommended since it has the higher multiplier of the short-circuit current.



Manual Motor Starters

Technical Information

Thermal limit on short circuit for MMS

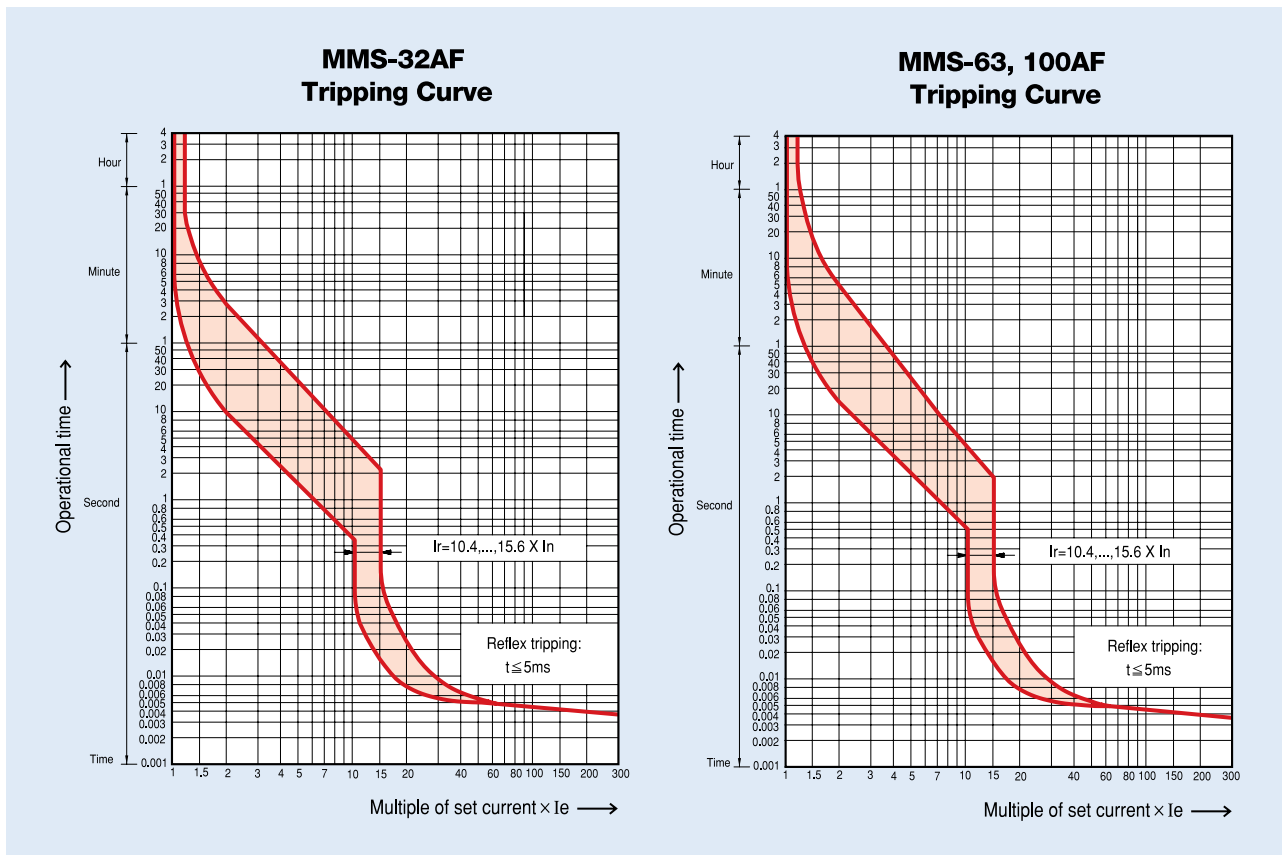

I) Thermal release trip current :

The adjustable inverse bimetal trip reliability protects motors against overloads.

The curve shows the mean operating current at an ambient temperature of 20°C starting from cold.

Careful testing and setting ensures effective motor protection even in the case of single-phasing.

II) Magnetic release trip current :

The instantaneous magnetic trip has a fixed operating current setting.

This corresponds to 13 times the maximum value of setting range,

at a lower setting it is correspondingly higher.

Current setting I_e :

The overload trip corresponds to a thermal overload relay in a motor starter conforming to IEC 947-4-1.

If a different value is prescribed (e.g. reduced I_e for cooling medium having a temperature higher

than 40°C or a place of installation higher than 2000m above sea level),

the setting current is equal to the reduced rated current I_e of the motor.

Technical Information

Thermal limit on short circuit for MMS

Thermal limit in kA^2s in the magnetic operating zone ($U_e=415\text{V}$)

- MMS-32S/H/HI

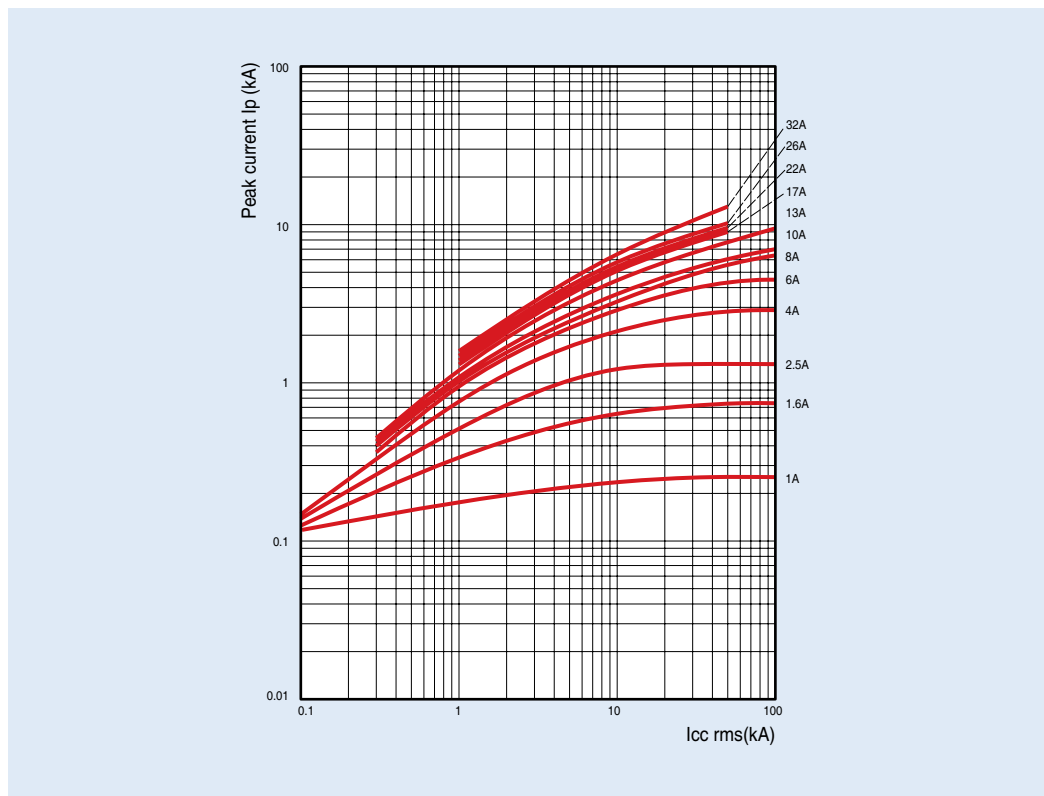
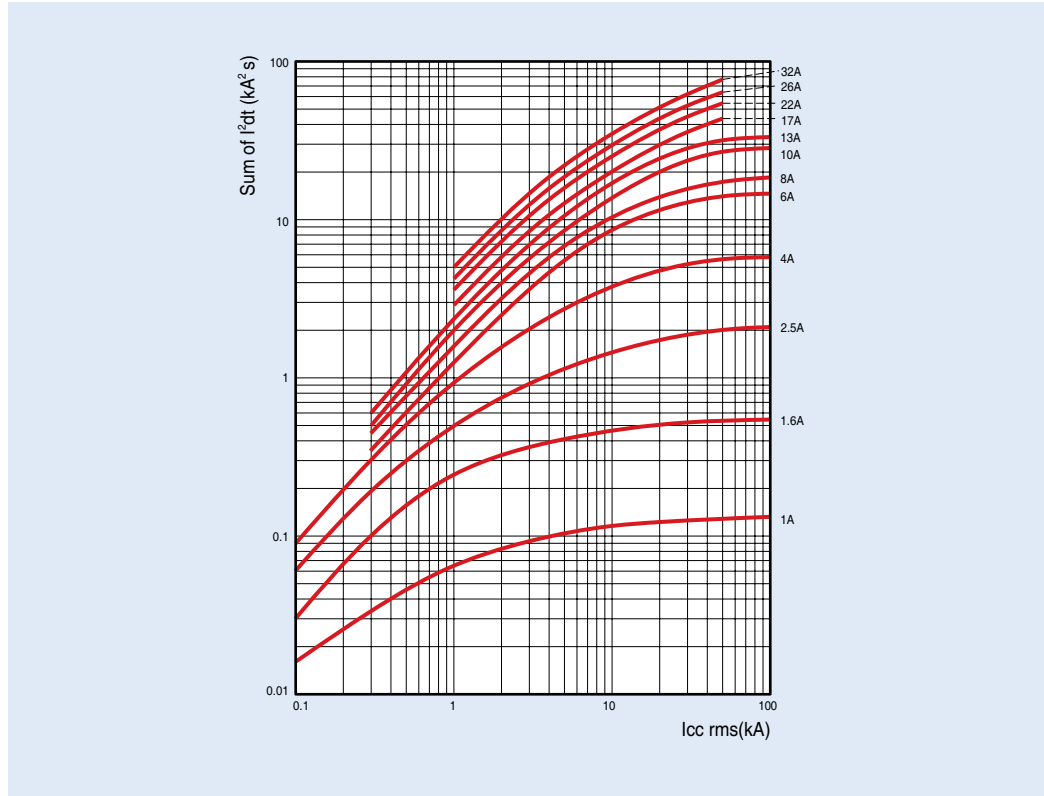

Manual Motor Starters

Technical Information

Thermal limit on short circuit for MMS

Thermal limit in kA^2s in the magnetic operating zone ($U_e=415\text{V}$)

- MMS-63S/H/HI

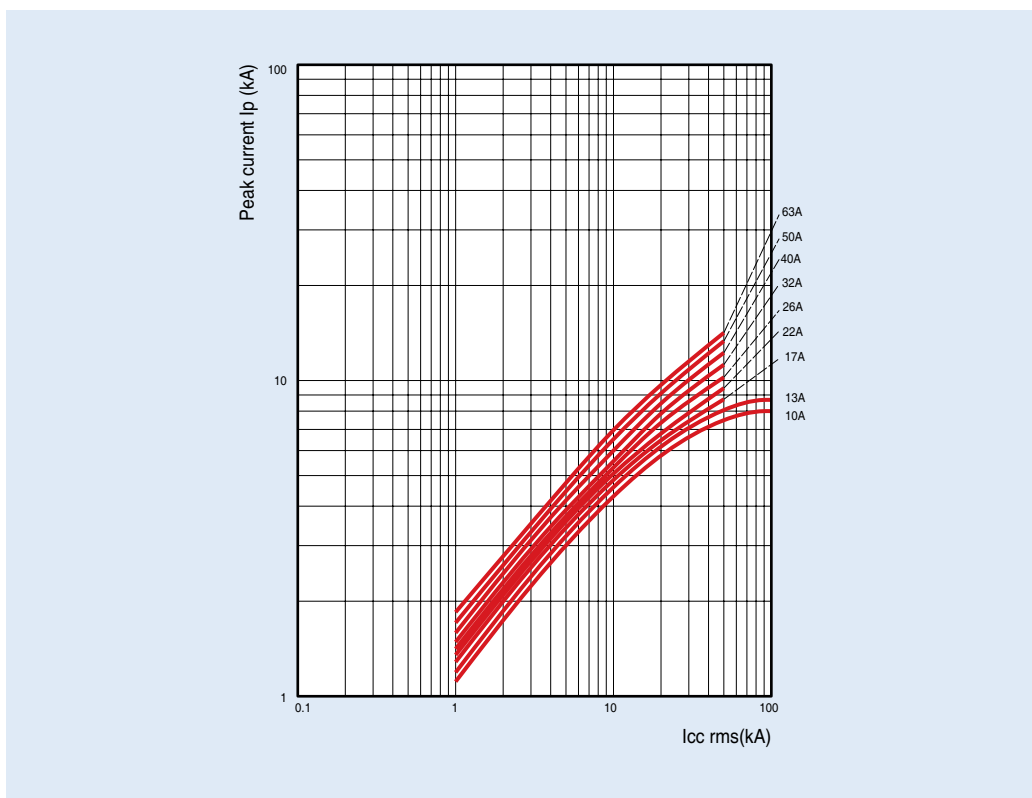
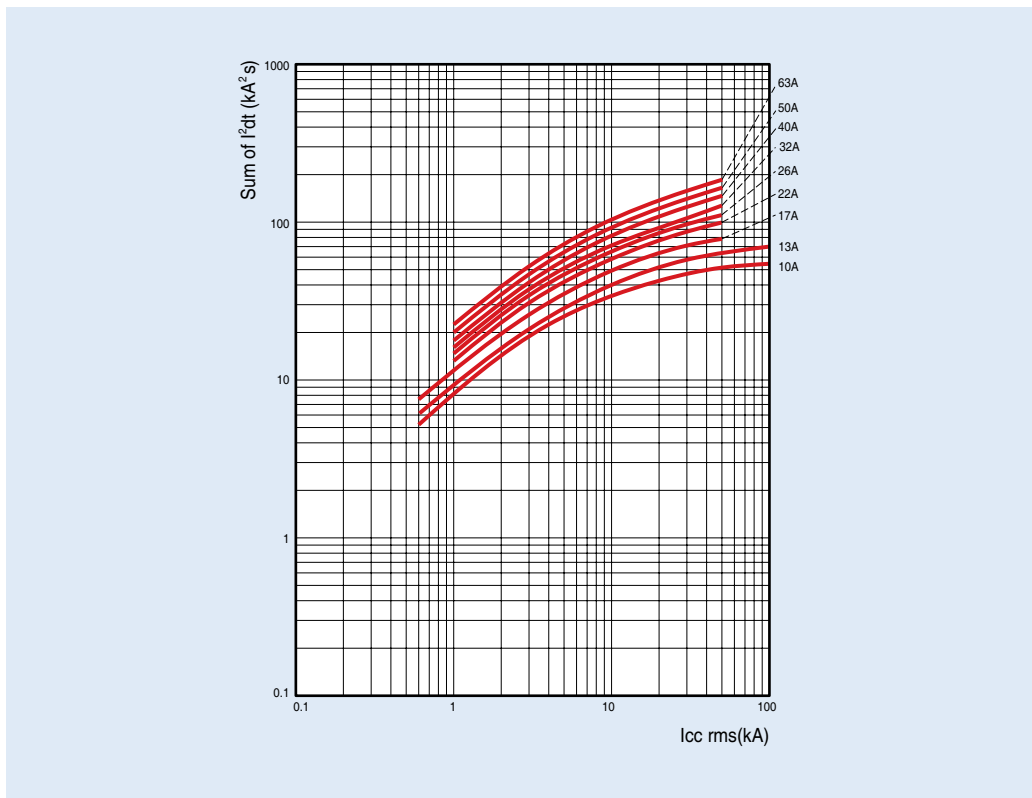

Thermal limit in kA^2s in the magnetic operating zone ($U_e=415V$)

- MMS-100S/H/Hi

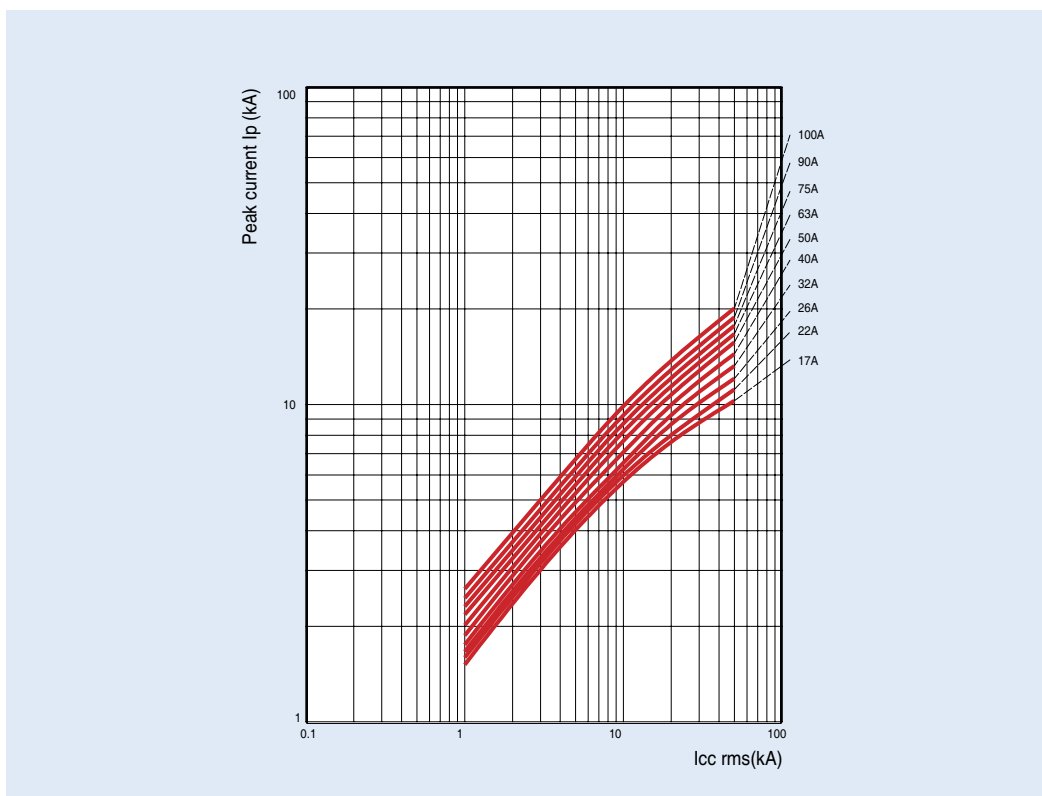
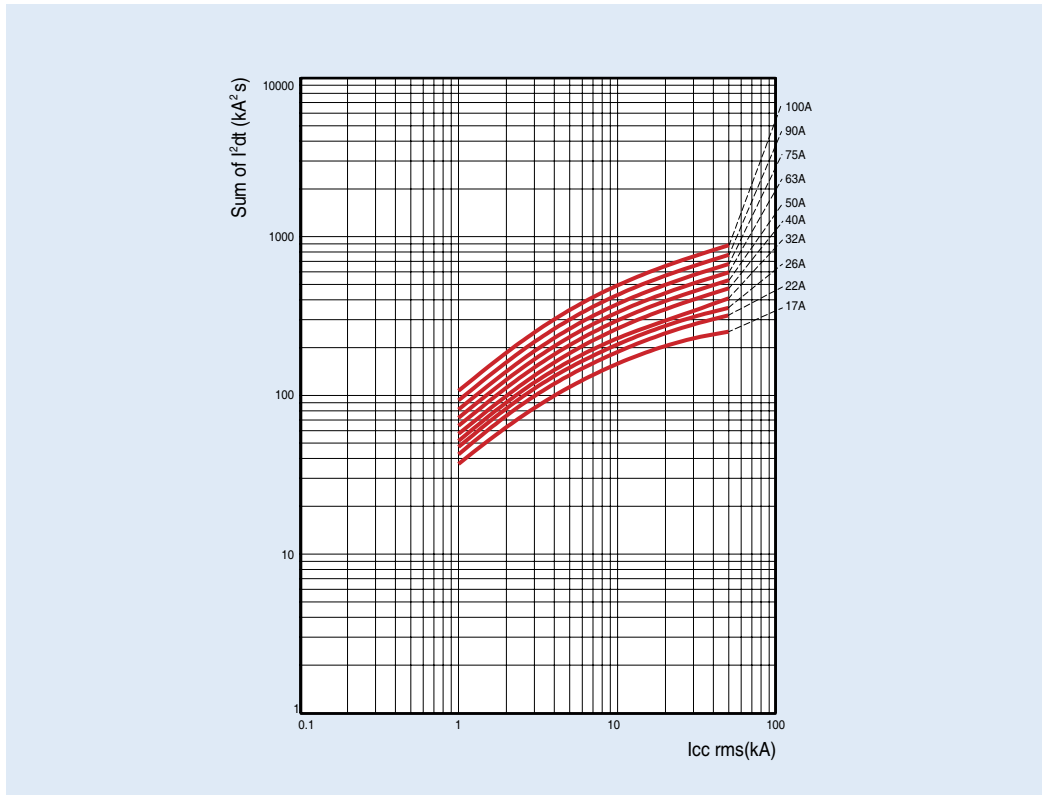

Manual Motor Starters

Technical Information

Dimension

• MMS 32S

[mm]

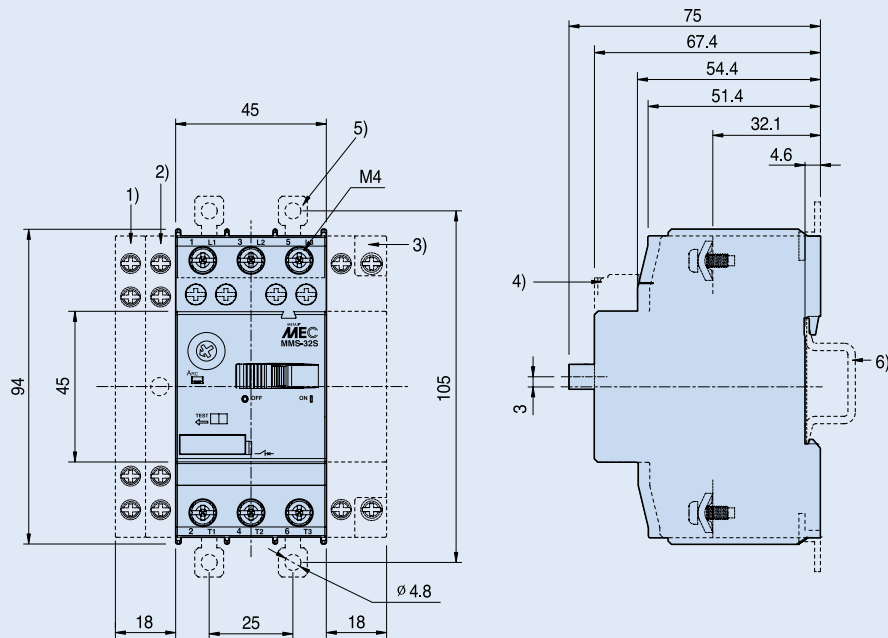

0.32kg

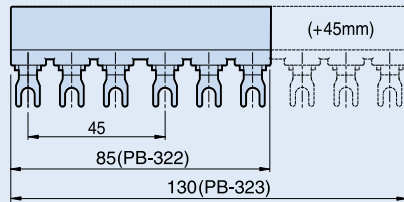
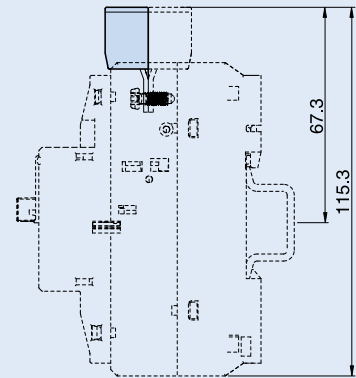
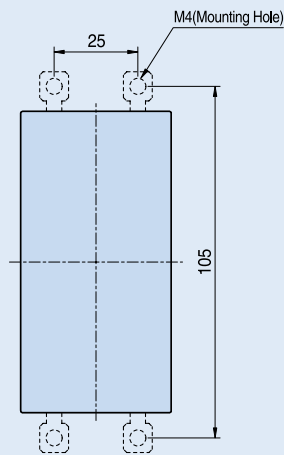

MMS-32S+PB-32(2, 3 Terminal)
PB-322(2 Terminal), PB-323(3 Terminal)
PB-324(4 Terminal), PB-325(5 Terminal)

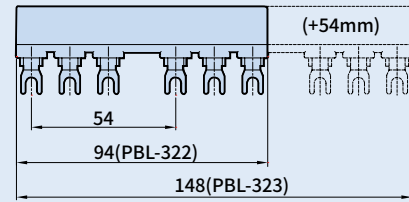

MMS-32S+PBL-32(2,3 Terminal)
PBL-322(2 Terminal), PBL-323(3 Terminal)

- 1) Side auxiliary switch
- 2) Side magnetic trip alarm switch
- 3) Side shunt release or Side undervoltage release
- 4) Front auxiliary switch
- 5) Push-in Lugs for screw mounting
- 6) 35mm standard mounting rail acc. to EN 50 022

● MMS 32H, 32HI

[mm]

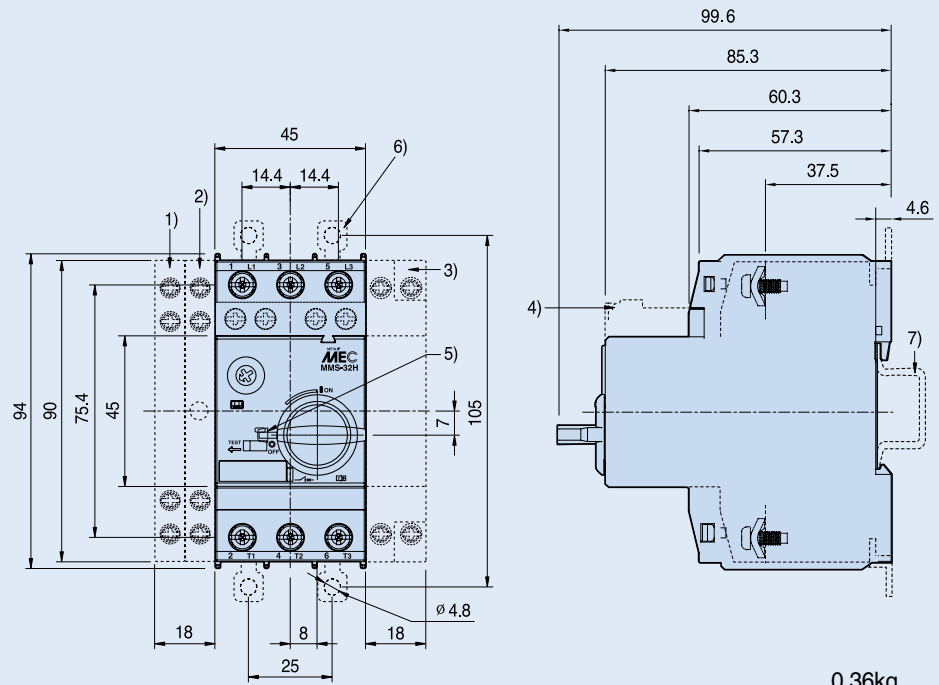

0.36kg

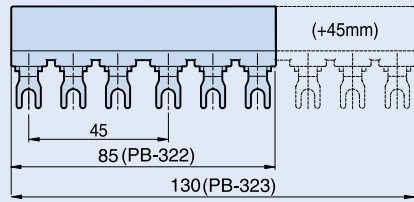
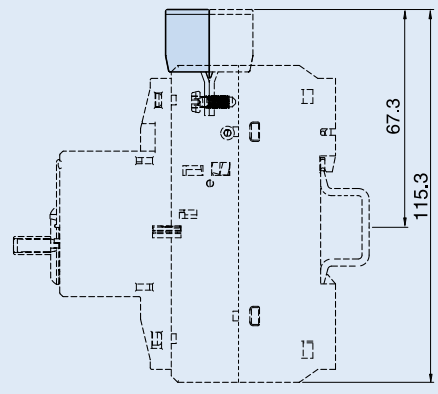
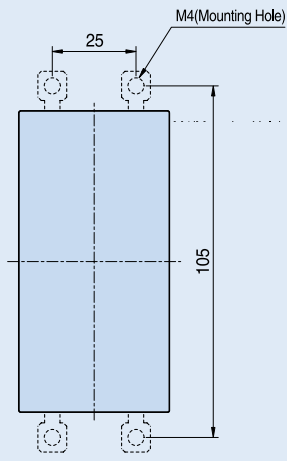

MMS-32H/HI+PB-32(2, 3 Terminal)
PB-322(2 Terminal), PB-323(3 Terminal)
PB-324(4 Terminal), PB-325(5 Terminal)

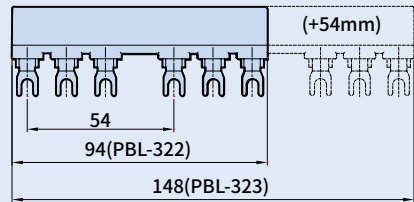

MMS-32H,HI+PBL-32(2,3 Terminal)
PBL-322(2 Terminal), PBL-323(3 Terminal)

- 1) Side auxiliary switch
- 2) Side magnetic trip alarm switch
- 3) Side shunt release or Side undervoltage release
- 4) Front auxiliary switch
- 5) Handle lock in OFF position(Ø5mm)
- 6) Push-in Lugs for screw mounting
- 7) 35mm standard mounting rail acc. to EN 50 022

Manual Motor Starters

Technical Information

Dimension

• MMS 63S, 63H, 63HI

[mm]

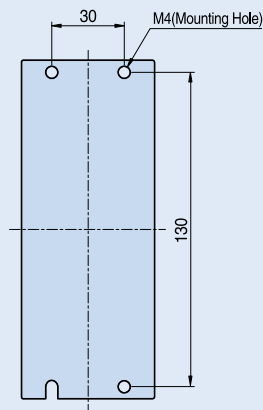
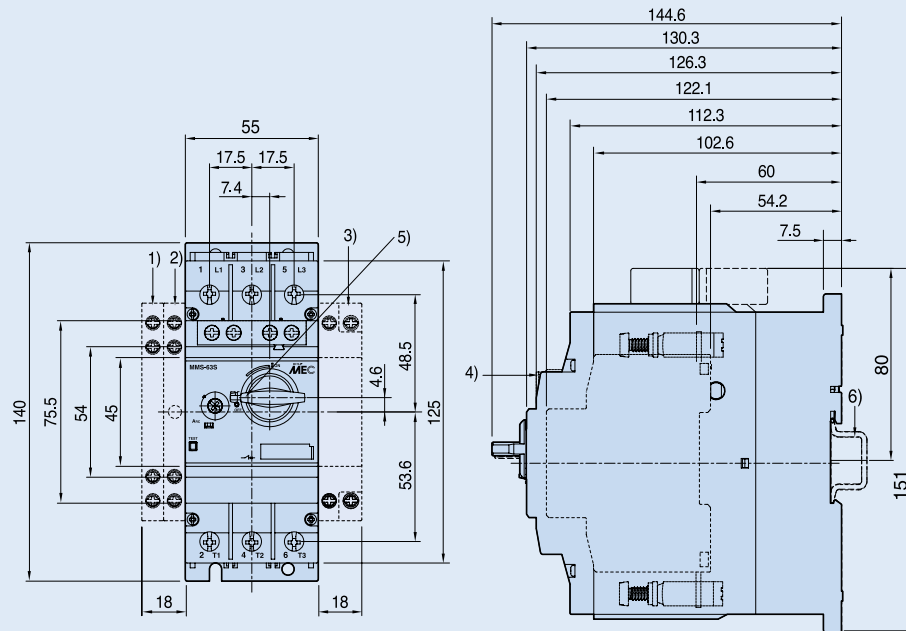

1kg

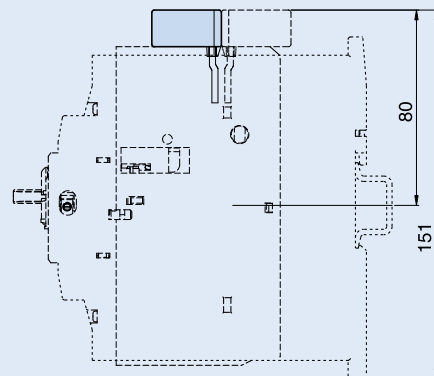
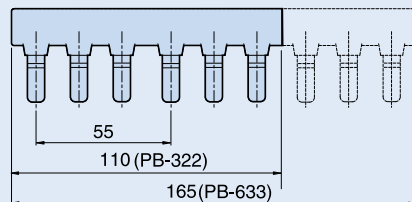

MMS-63S/H/HI+PB-63(2, 3 Terminal)
PB-632(2 Terminal), PB-633(3 Terminal)

- 1) Side auxiliary switch
- 2) Side magnetic trip alarm switch
- 3) Side shunt release or Side undervoltage release
- 4) Front auxiliary switch
- 5) Handle lock in OFF position(\varnothing 5mm)
- 6) 35mm standard mounting rail acc. to EN 50 022

● MMS 100S, 100H, 100HI

[mm]

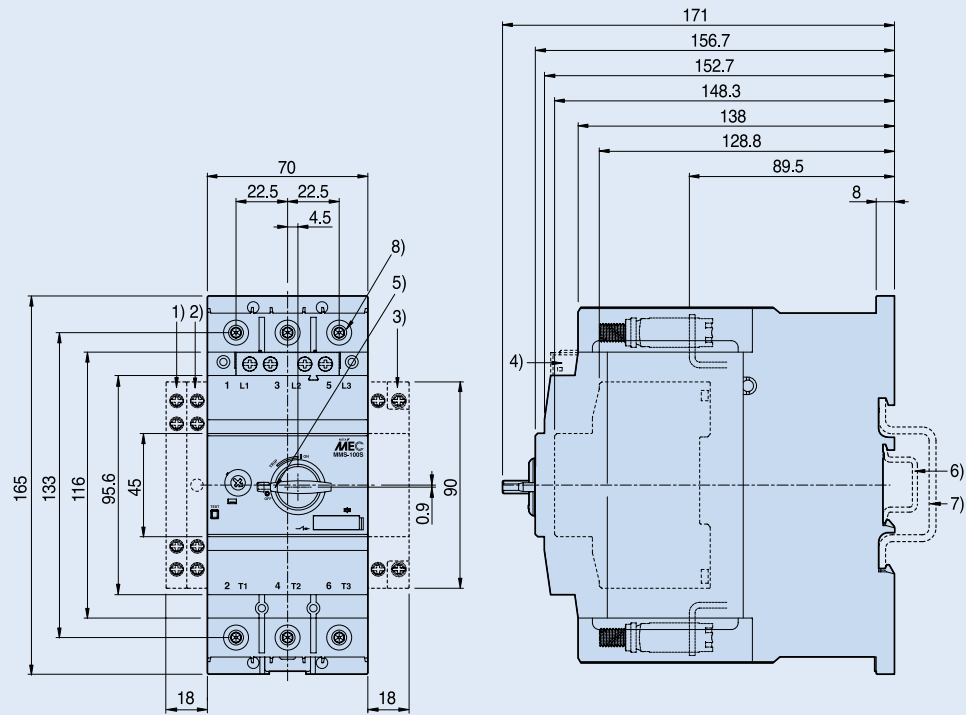

2.2kg

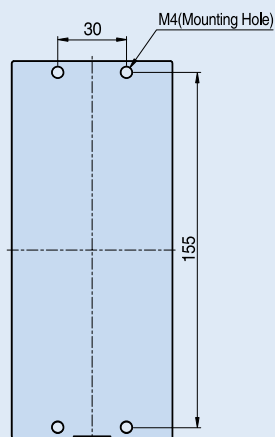

- 1) Side auxiliary switch
- 2) Side magnetic trip alarm switch
- 3) Side shunt release or Side undervoltage release
- 4) Front auxiliary switch
- 5) Handle lock in OFF position(Ø5mm)
- 6) 35mm standard mounting rail acc. to EN 50 022
- 7) 75mm standard mounting rail acc. to EN 50 023
- 8) 4mm hexagon socket screw

Manual Motor Starters

Technical Information

Dimension

• MMS + Mini-MS

[mm]

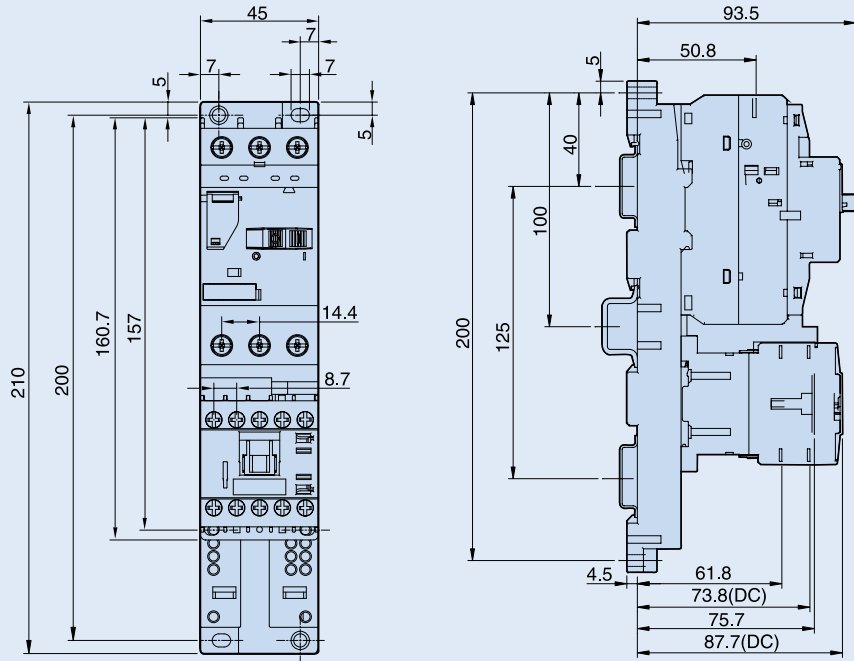

MMS-32S+GMC(D)-6M~16M

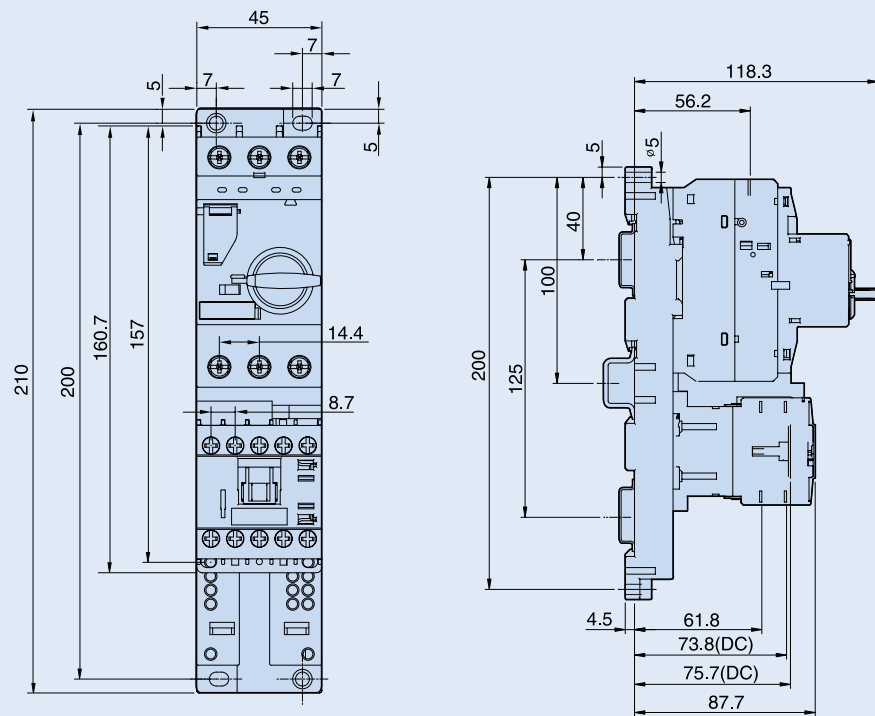

MMS-32H+GMC(D)-6M~16M

● MMS + Susol MC

[mm]

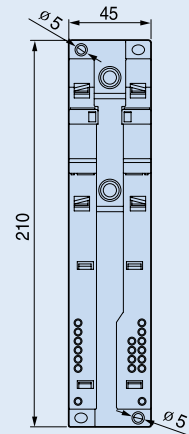
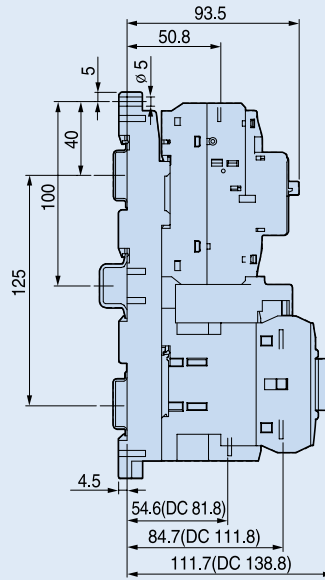
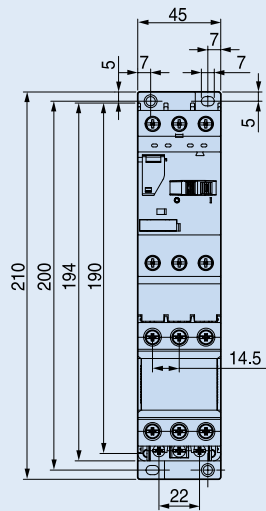

**MMS-32S
+
MC-32AF**

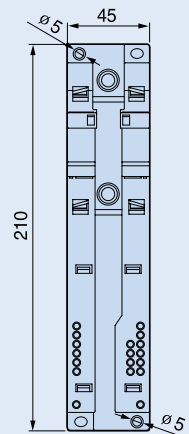
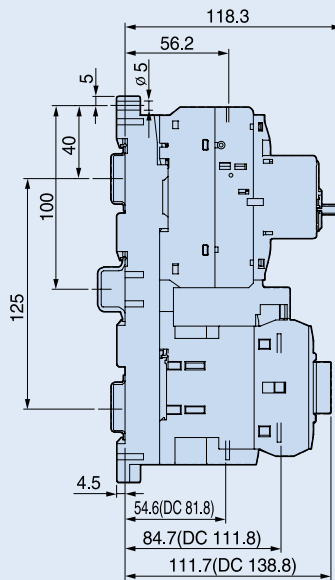
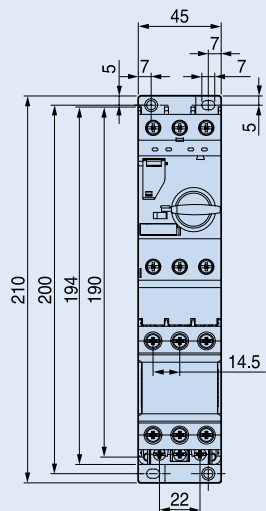

**MMS-32H
+
MC-32AF**

Manual Motor Starters

Technical Information

Dimension

• MMS + Susol MC

[mm]

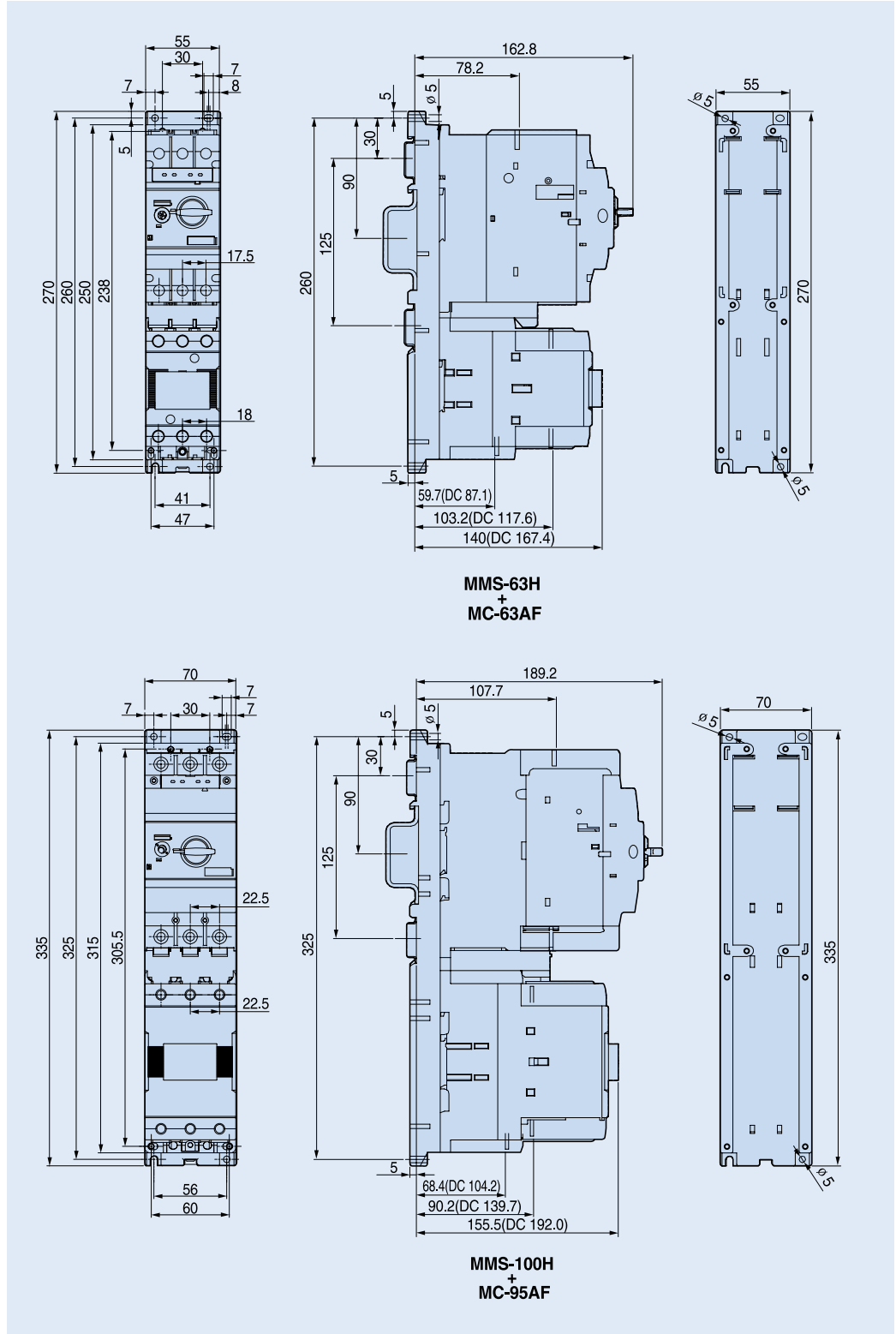

● E-Handle

[mm]

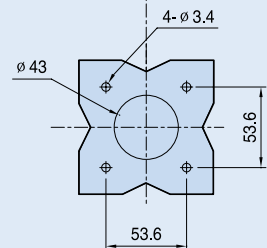
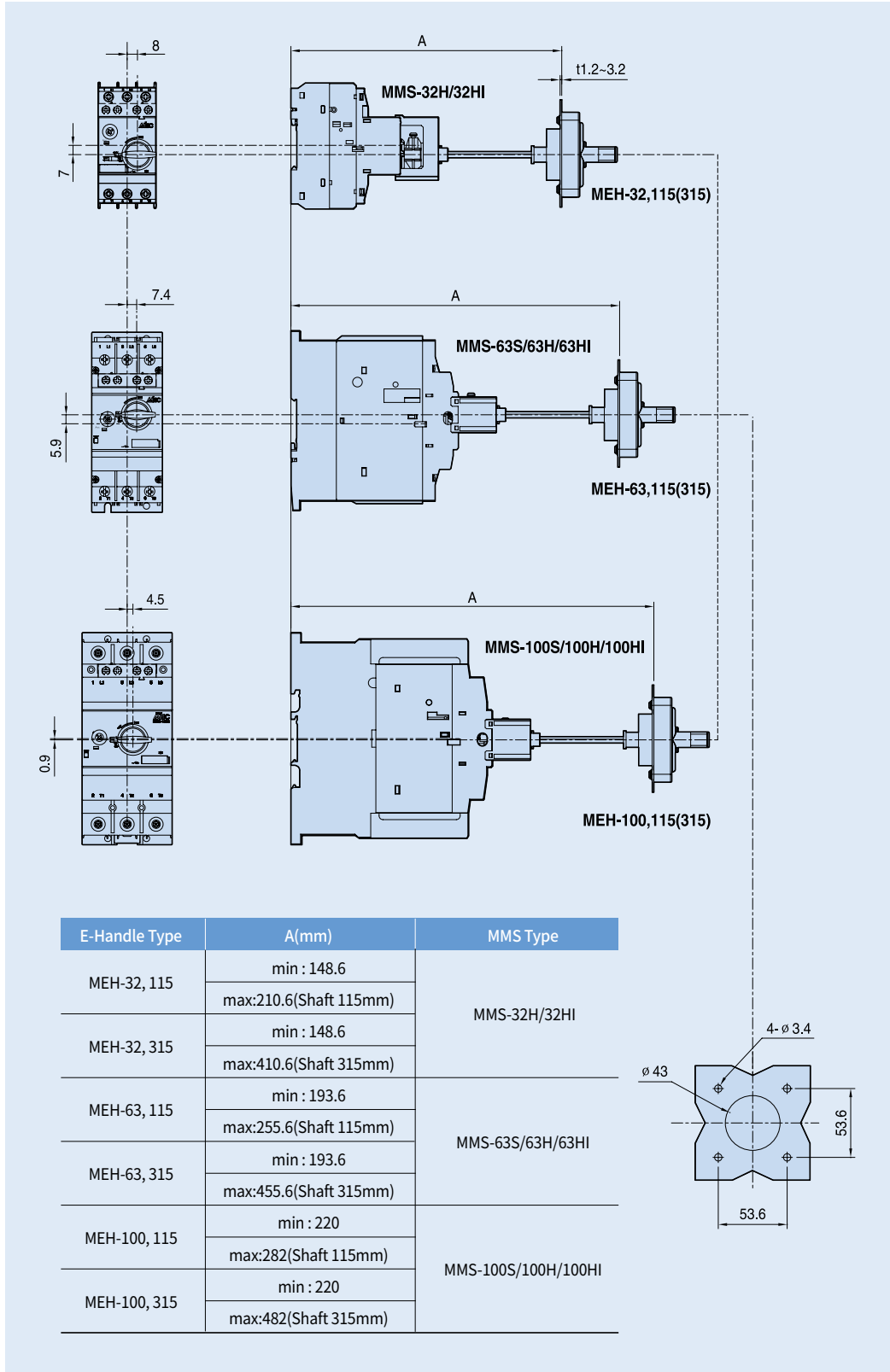

Manual Motor Starters

Technical Information

Dimension

● Enclosure

[mm]

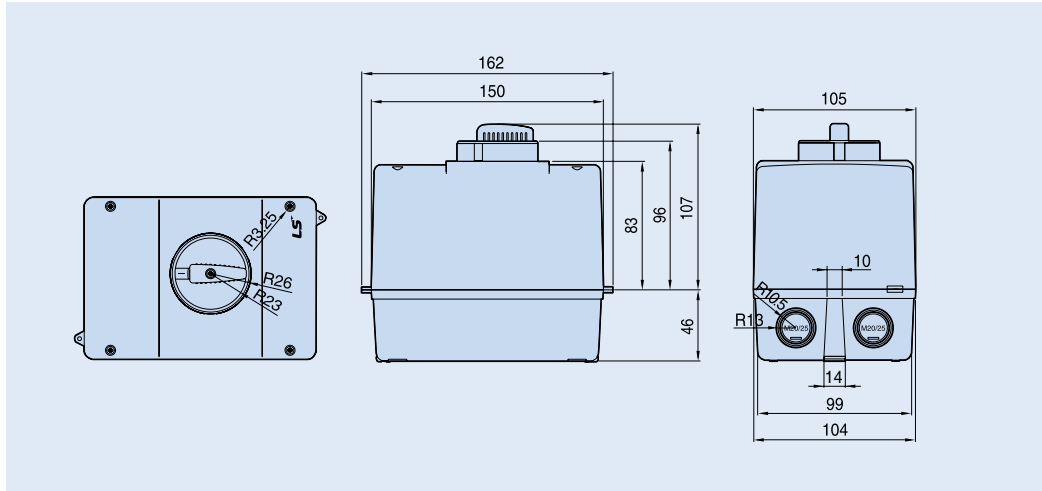

● Phase Bus

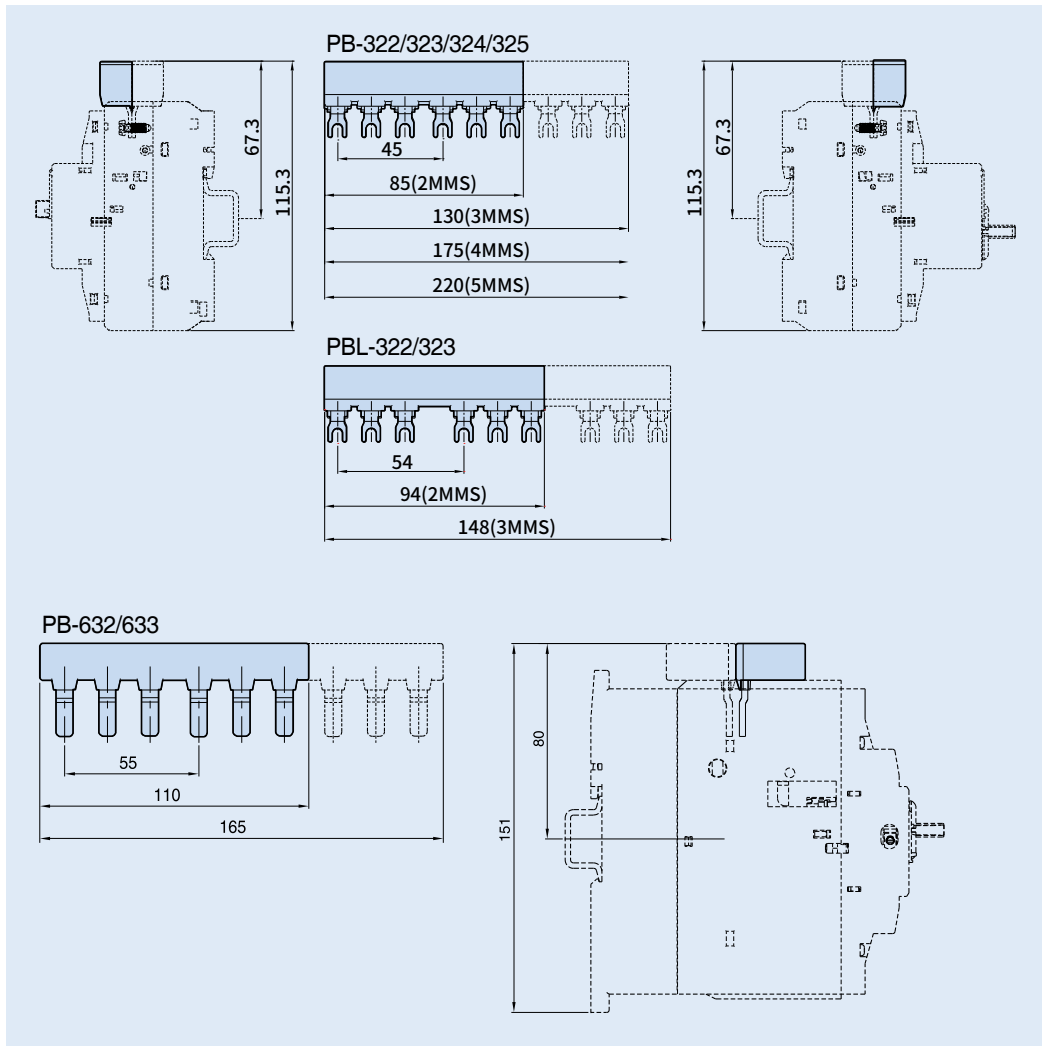

Memo

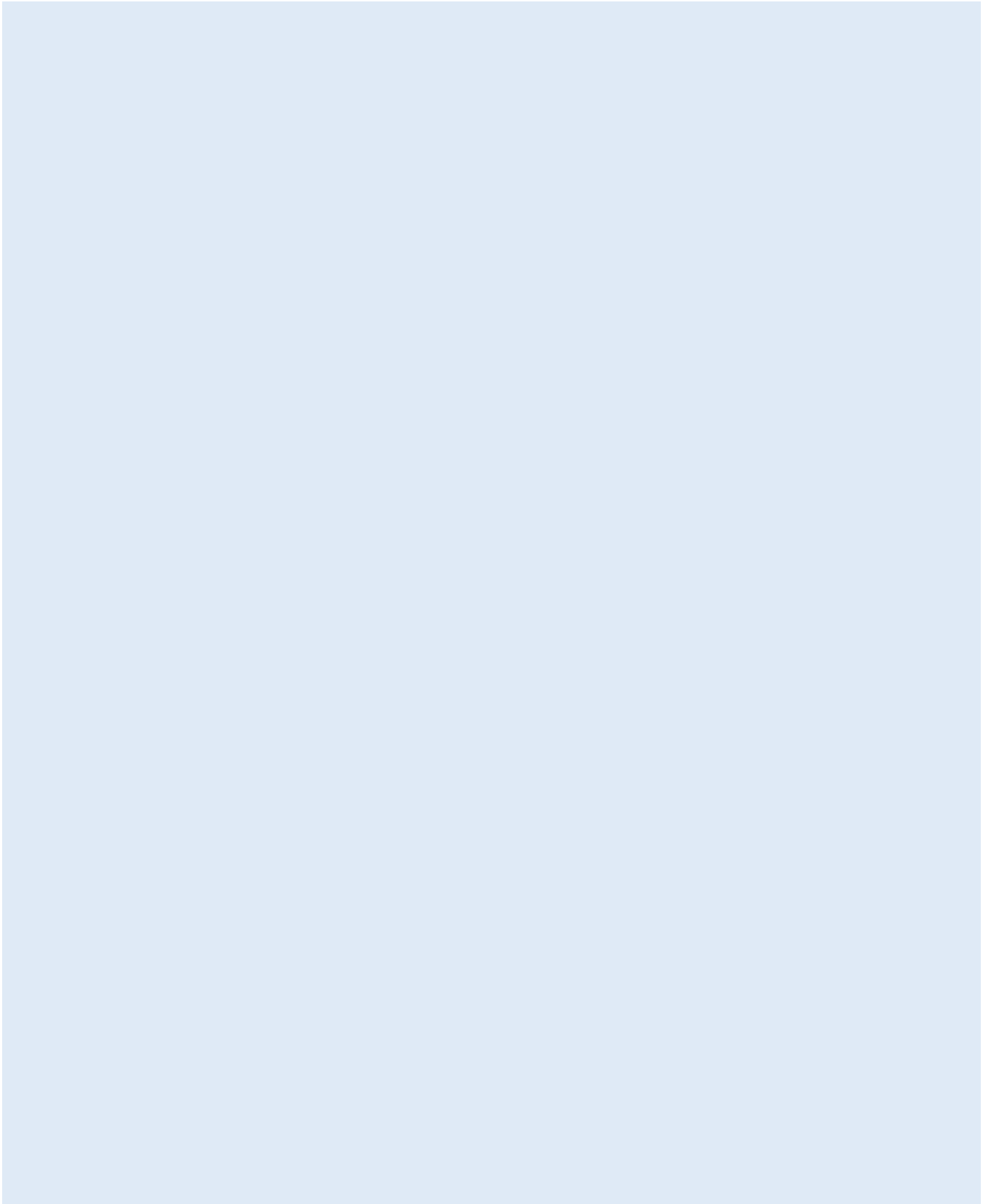



Safety Instructions

- For your safety, please read user's manual thoroughly before operating.
- Contact the nearest authorized service facility for examination, repair, or adjustment.
- Please contact qualified service technician when you need maintenance. Do not disassemble or repair by yourself!
- Any maintenance and inspection shall be performed by the personnel having expertise concerned.



- According to The WEEE Directive, please do not discard the device with your household waste.



www.lselectric.co.kr

■ **Headquarter**

LS-ro 127(Hogye-dong) Dongan-gu, Anyang-si, Gyeonggi-Do, 14119, Korea

■ **Seoul Office**

LS Yongsan Tower, 92, Hangang-daero, Yongsan-gu, Seoul, 04386, Korea
Tel: 82-2-2034-4916, 4684, 4429

■ **Overseas Subsidiaries**

- **LS ELECTRIC Japan Co., Ltd. (Tokyo, Japan)**
Tel: 81-3-6268-8241 E-Mail: jschuna@lselectric.biz
- **LS ELECTRIC (Dalian) Co., Ltd. (Dalian, China)**
Tel: 86-411-8730-5872 E-Mail: jiheo@lselectric.com.cn
- **LS ELECTRIC (Wuxi) Co., Ltd. (Wuxi, China)**
Tel: 86-510-6851-6666 E-Mail: sblee@lselectric.co.kr
- **LS ELECTRIC Vietnam Co., Ltd.**
Tel: 84-93-631-4099 E-Mail: jhchoi4@lselectric.biz (Hanoi)
Tel: 84-28-3823-7890 E-Mail: sjbaik@lselectric.biz (Hochiminh)
- **LS ELECTRIC Middle East FZE (Dubai, U.A.E.)**
Tel: 971-4-886-5360 E-Mail: hschoib@lselectric.biz
- **LS ELECTRIC Europe B.V. (Hoofddorp, Netherlands)**
Tel: 31-20-654-1424 E-Mail: europartner@lselectric.biz
- **LS ELECTRIC America Inc. (Chicago, USA)**
Tel: 1-800-891-2941 E-Mail: sales.us@lselectricamerica.com

■ **Overseas Branches**

- **LS ELECTRIC Tokyo Office (Japan)**
Tel: 81-3-6268-8241 E-Mail: jschuna@lselectric.biz
- **LS ELECTRIC Beijing Office (China)**
Tel: 86-10-5095-1631 E-Mail: chendm@khpaeck.com.cn
- **LS ELECTRIC Shanghai Office (China)**
Tel: 86-21-5237-9977 E-Mail: khpaek@lselectric.com.cn
- **LS ELECTRIC Guangzhou Office (China)**
Tel: 86-20-3818-2883 E-Mail: chenxs@lselectric.com.cn
- **LS ELECTRIC Chengdu Office (China)**
Tel: 86-28-8670-3201 E-Mail: yangcf@lselectric.com.cn
- **LS ELECTRIC Qingdao Office (China)**
Tel: 86-532-8501-2065 E-Mail: wangzy@lselectric.com.cn
- **LS ELECTRIC Nanjing Office (China)**
Tel: 86-25-8467-0005 E-Mail: ylong@lselectric.com.cn
- **LS ELECTRIC Bangkok Office (Thailand)**
Tel: 66-90-950-9683 E-Mail: sjleet@lselectric.biz
- **LS ELECTRIC Jakarta Office (Indonesia)**
Tel: 62-21-2933-7614 E-Mail: yjlee@lselectric.biz
- **LS ELECTRIC Moscow Office (Russia)**
Tel: 7-499-682-6130 E-Mail: jdpark1@lselectric.biz
- **LS ELECTRIC America Western Office (Irvine, USA)**
Tel: 1-949-333-3140 E-Mail: jwyun@lselectricamerica.com



Technical Question or After-sales Service

Customer Center-Quick Responsive Service, Excellent technical support | **82-1644-5481**